

HVAC Air-Trap™

WATERLESS HVAC CONDENSATE TRAPS



RESIDENTIAL
COMMERCIAL
INDUSTRIAL
INSTITUTIONAL

PRODUCT & ENGINEERING CATALOG



DES CHAMPS
Technologies®

www.deschampstechnologies.com

www.waterless-trap.com

1.540.228.1967





DES CHAMPS
Technologies®

2 Nikki Lane
Natural Bridge Station, VA 24579
Phone: 540.228.1967
Fax: 540.291.1270
info@deschampstechnologies.com
www.deschampstechnologies.com
www.waterless-trap.com

Copyright 2022 Des Champs Technologies

HVAC Air-Trap™

PRODUCT & ENGINEERING CATALOG

Table of Contents

General Information	4
Maximum Pressure and Condensate Flow	5
Product Information	7
Key Drawings	21
Condensate Removal from HVAC Equipment - Sample Specification	28
Installation, Operation and Maintenance Manuals (IOMs)	30
Air Leakage Data	47
Analysis of Energy Wasted when Injecting Ambient Air Downstream of Cooling Coil	49
Material Data	53
White Paper	57
Frequently Asked Questions	69
Where to Buy	70

HVAC Air-Trap™

WATERLESS HVAC CONDENSATE TRAPS

No More Troublesome "P" Traps

- *Air-Trap* reduces trap height by up to 60%. A total height equal to the maximum water pressure in inches WC. With negative pressure plenum, the HVAC *Air-Trap* requires less than 1/2 the height required for P-Trap installation.
- Built in clean-out port to meet building code IRC section M1411.3.3, IMC Section 307.2.5, UMC Section 312.3.1, which states: "Condensate drain lines shall be configured to permit the clearing of blockages and performance of maintenance without requiring the drain line to be cut."
- The *Air-Trap* will never freeze and break.
- No more issues caused by traps drying out, does not require filling with water in spring or after extended period of no condensate formation.
- Designed to prevent standing water within the trap and drain line when there is no condensate being produced.
- *Air-Trap* is predesigned and site proven to prevent field errors.
- Eliminates sludge build-up at bottom of "U" tube.
- Prevent the geyser effect with "dry trap" and negative plenum pressure.
- No more blow through with positive pressure.

HVAC Air-Trap Concept

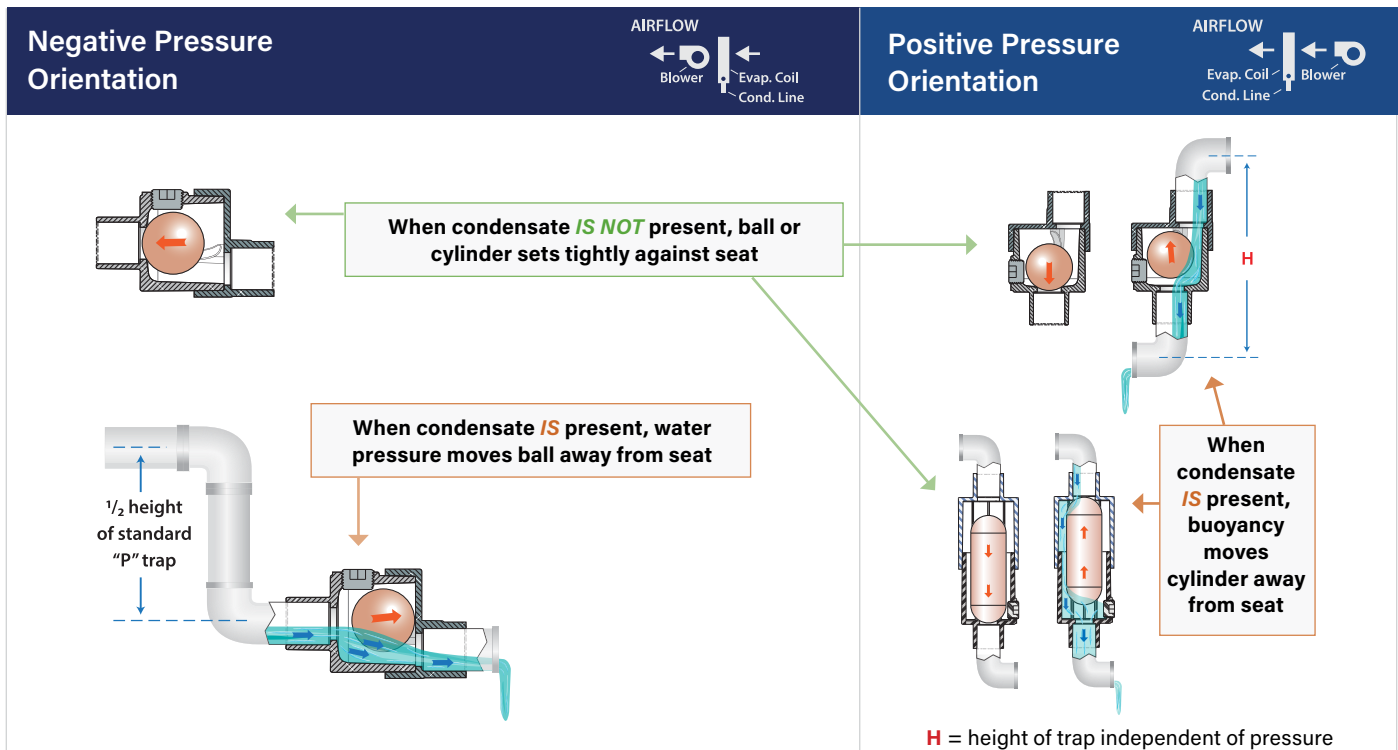

Note: The drawings within this catalog represent traps that operate under negative or positive pressure. **Never connect condensate drain directly to a sanitary drain line.**



N, P, RLC, FCN and PLP-Series Air-Traps are Patented



FCN-Series

Compact Residential / Lite Commercial Negative Pressure Waterless Trap
Perfect for Ductless Mini-splits

RLC-Series

Residential / Lite Commercial Waterless Trap
Can be used as negative or positive pressure trap

N-Series

Negative Pressure Waterless Trap
Can be used as negative or positive pressure trap

P-Series

Positive Pressure Waterless Trap

PLP-Series

Positive Pressures Ranging from 0 to 40 inches WC

Maximum Condensate Flow, GPM, at Pressure Shown in Inches Water Column

Air-Trap Series	Any Negative Pressure	Positive Pressure
FCN	0.8	0.04 at 0.5" WC
RLC	2.0	0.06 at 5" WC
		0.19 at 4" WC
		0.21 at 3" WC
		0.21 at 2" WC
N all connection sizes	2.0	0.06 at 5" WC
		0.19 at 4" WC
		0.21 at 3" WC
		0.21 at 2" WC

Air-Trap Series	Negative Pressure	Positive Pressure
P all connection sizes	N/A	0.5 at 12" WC
		1.0 at 8" WC
		1.5 at 7" WC
		2.0 at 4" WC
PLP-084	N/A	2.2 at 25" WC
		2.5 at 15" WC
		4.0 at 0.5" WC
PLP-051	N/A	0.8 at 5" WC
		0.95 at 2" WC

Sizes and Pressures

Air-Trap Series	Max Negative Pressure, inches WC	Max Positive Pressure, inches WC	Available Connection Sizes (inches)				Length (inches)
			3/4	1	1-1/4	1-1/2	
P	N/A	12	3/4	1	1-1/4	1-1/2	8
N	20	3	3/4	1	1-1/4	1-1/2	5.6
RLC	20	2.5	3/4	1 (with fitting)			4.65
FCN	5	0.5	3/4	1/2 (with fitting)			2.48
PLP-084	N/A	0 - 40	1-1/2		2 (with fitting)		7.75
PLP-051	N/A	0 - 5	3/4	1 (with fitting)			5.6

HVAC Air-Trap and Standard P-Trap Required Space Comparison when at Negative Pressure

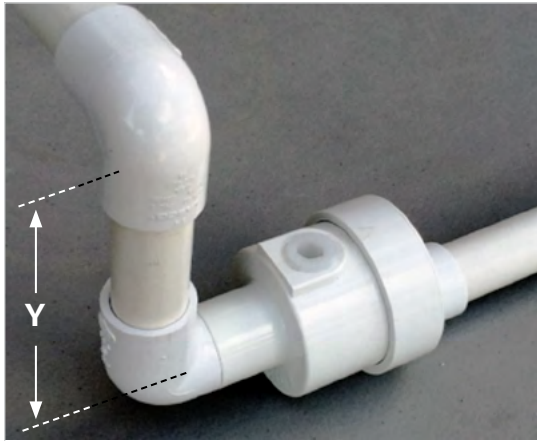

Dimension Y in inches is = negative pressure in inches of WC.

Plenum Pressure inches of WC	Standard P-Trap	HVAC Air-Trap™	Difference
	Minimum Required Height, Y*	Minimum Required Height, Y	
1	4	2	2
2	6	3	3
3	8	4	4
4	10	5	5
5	12	6	6
6	14	7	7
7	16	8	8
8	18	9	9
9	20	10	10
10	22	11	11

Measurements in inches

* Height "Y" for the standard P-Trap does not take into consideration any evaporation of the condensate within the U-shaped section of the trap. Please refer to page 61 for information to guide you in the correct design of a P-Trap that allows the trap to hold water all year and prevent air leakage through the drain line.

Total height of the Air-Trap is only the height of the negative pressure plus one inch for safety and not 2 times negative pressure plus two inches.

The table is for negative pressure systems since no water head is required for the Air-Trap in positive pressure systems.

Standard P-Trap Design

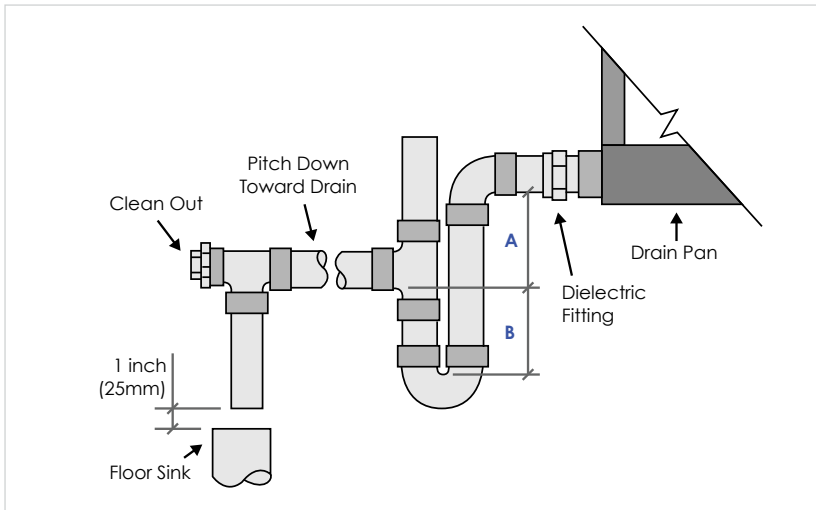

The Air-Trap™ concept has been incorporated into IAPMO IGC 196-2018 *Standard for Condensate Traps and Overflow Switches for Air-Conditioning Systems*.

**Air-Traps meet
IMC® Code Section M307.2.4.1**

Unit Type	A	B
DrawThru	2" plus X	X
BlowThru	1" minimum	2X

Where X = Static Pressure downstream of Cooling Coil, inches WC

HVAC *Air-Trap*[™]

PRODUCT OVERVIEW



Negative Pressure Orientation



Positive Pressure Orientation

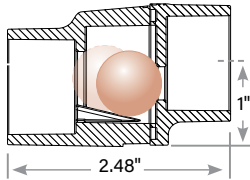

FCN-Series

Compact Residential / Lite Commercial Negative Pressure Waterless Trap

*Can be used as a positive pressure trap

Features

- Condensate flow up to 0.8 GPM at 2" negative pressure
- Schedule 40 PVC with easy maintenance, side clips to open the Air-Trap for cleaning
- Retains no water after condensing has ceased
- 3/4" internal slip or fitting (can connect to 1/2" via reducer coupling)
- Perfect for ductless mini-splits
- Meets general building codes. For use on HVAC equipment only. Not for use as a sanitary trap.

Specifications

Maximum negative pressure of WC	5"
Maximum positive pressure of WC	1/2"
Length	2.48"

Available models and connection sizes

3/4" Clear



FCN-051

3/4" White



FCN-051-W

***Will fit 1/2" with reducer coupling**

Flammability rating: UL94 V-0

Condensate flow data (GPM): Page 5

Air leak data: Page 47

FCN-Series Key Drawing: Page 22

FCN-Series Operation

When condensate *IS NOT* present, the ball sets tightly against the seat.

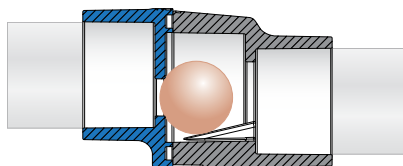

When condensate *IS* present, water pressure moves the ball away from the seat.

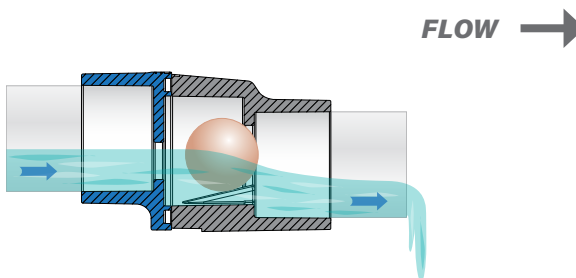

FCN-Series Installations



FCN-Series installed in negative pressure orientation.



FCN-Series indoor commercial installation in negative pressure orientation.



FCN-Series indoor residential attic install, negative pressure orientation. Tight space no problem, all thumbs up from the technician!



FCN-Series negative pressure commercial installation, an Air-Trap on both the main condensate drain pan line and secondary pan line.



Negative Pressure Orientation



Positive Pressure Orientation

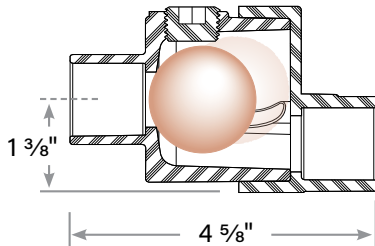

RLC-Series

Residential/Lite Commercial
Negative or Positive Pressure Waterless Trap

Features

Negative pressure: Orientation is horizontal

- Condensate flow up to 2 GPM at any negative pressure
- Schedule 40 PVC with clean out port
- Retains no water after condensing has ceased
- 3/4" slip internal or 1" fitting external connection - with bushings can connect to 1/2, 1-1/4, 1-1/2 and 2" tubes
- Meets general building codes. For use on HVAC equipment only. Not for use as a sanitary trap.

Positive pressure: Orientation is vertical

- Up to 3-inches positive pressure
- Up to 0.2 GPM water flow (≈ 20 tons)

Specifications

Maximum negative pressure of WC	20"
Maximum positive pressure of WC	3"
Length	4.65"

Available models and connection sizes

3/4" Clear



RLC-051-C

3/4" White



RLC-051

***Will fit 1" with fitting**

Flammability rating: UL94 V-0
Condensate flow data (GPM): Page 5

Air leak data: Page 47
RLC-Series Key Drawing: Page 23

RLC-Series Operation

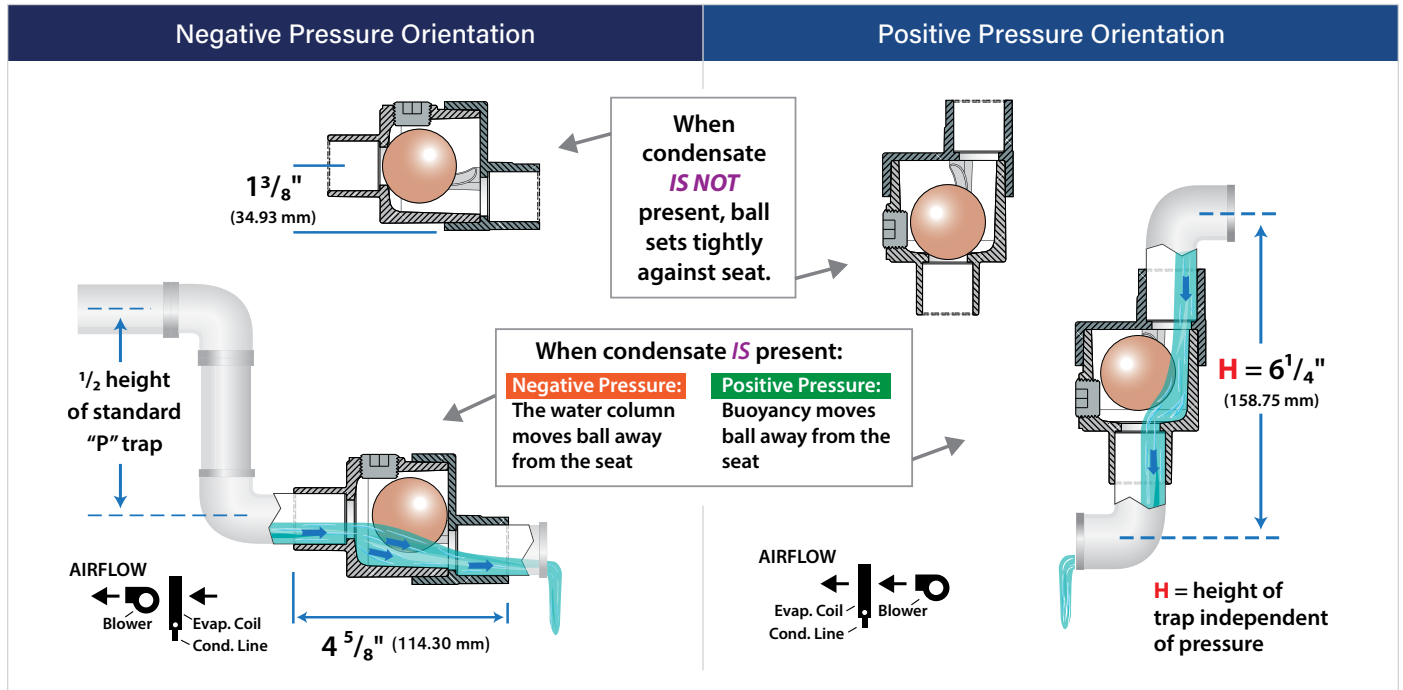

RLC-Series Installations



RLC-Series negative pressure trap replaced a leaking standard P-Trap that didn't have enough height to function properly.



Attic residential RLC-Series negative pressure installation in combination with condensate pump.



RLC-Series negative pressure commercial rooftop installation.



RLC Series negative pressure installation in a data center facility.



Negative Pressure Orientation



Positive Pressure Orientation

N-Series

Negative or Positive Pressure Waterless Trap

Benefits

- Reduces sludge buildup that normally accumulates in standard "P" trap
- Prevents water blow out when condensate begins to form at the beginning of cooling season when trap has dried and air is rushing into HVAC unit plenum, causing water spray into fan plenum compartment
- Since there is no water in the trap, there is no chance of freezing during cold periods.
- Reduces the trap height by approximately 50% as compared to the "P" trap

Features

- Schedule 40 PVC with clean out port
- Retains no water after condensing has ceased
- Meets general building codes.

Specifications

Maximum negative pressure of WC	20"
Maximum positive pressure of WC	3"
Length	5.6"

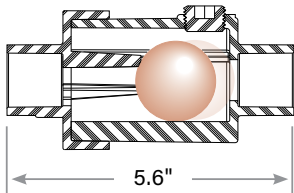

Available connection sizes

3/4" Clear



NCC-H51P-NO

1" Clear

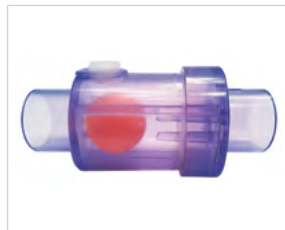

NCC-H62P-NO

1-1/4" Clear

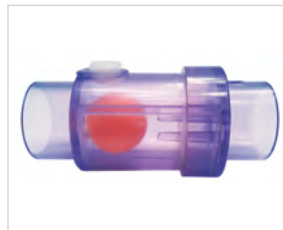

NCC-H73P-NO

1-1/2" Clear



NCC-H84P-NO

3/4" White



NCE-H51P-NO

1" White



NCE-H62P-NO

1-1/4" White



NCE-H73P-NO

1-1/2" White



NCE-H84P-NO

Flammability rating: UL94 V-0

Condensate flow data (GPM): Page 5

Air leak data: Page 47

N-Series Key Drawing: Page 24

N-Series Operation

Figure 1: Shows for a standard “P” Trap the vertical distance required between center lines of unit connection and the center line of the bottom of the trap is 4 inches when there is a 2-inch negative plenum pressure. By comparison, the Air-Trap N-Series is only 2 inches, not the 4 inches required with the standard “P” trap.

Figure 2: When condensate is not present, the negative pressure within the plenum draws the internal mechanism against the valve seat preventing air from entering the AHU through the drainpipe.

Figure 3: As condensate forms, water builds up in the vertical pipe. When the water pressure equals the negative air pressure in inches of water column, the force of the water head becomes equal or greater than the negative pressure — the internal mechanism moves to the right, and water flows.

Figure 4: When there is no longer a requirement to remove condensation, the negative pressure returns the ball to the valve seat and prevents airflow to the unit plenum. The internal rails aid in returning the ball to the seat in case the variable speed fan is operating at a low flow and low negative pressure.

Figure 1: Trap Required in Condensate Line
If the condensate drain line is under negative pressure (e.g., upstream of blower as shown here) a trap is required.

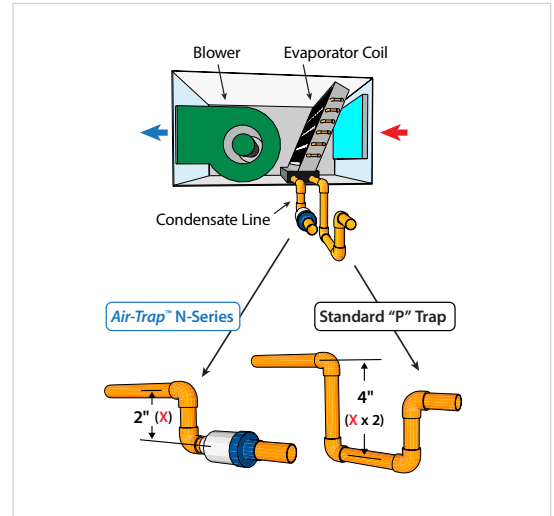

Figure 2

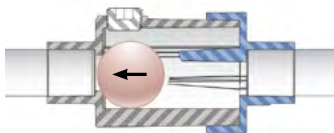
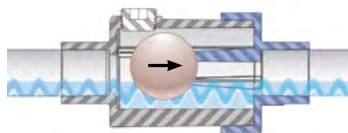
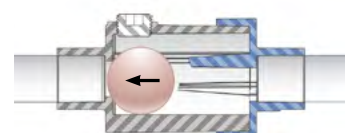

Figure 3



FLOW →

Figure 4



N-Series Installations



N-Series, commercial mechanical room negative pressure installation.

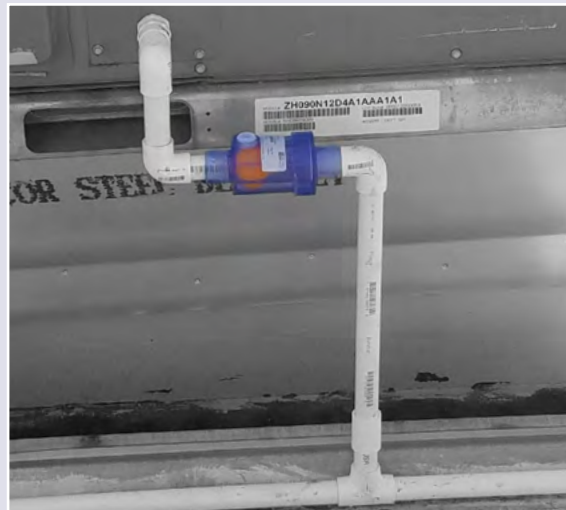

N-Series commercial rooftop negative pressure installation.



Positive Pressure Orientation

P-Series

Positive Pressure Waterless Trap

Features

- Schedule 40 PVC with clean out port
- Retains no water after condensing has ceased
- Requires no water head to cause trap to operate
- Meets general building codes. For use on HVAC equipment only. Not for use as a sanitary trap.

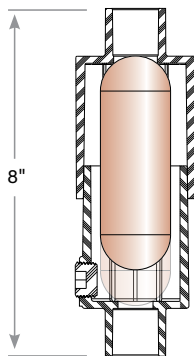

Specifications

Maximum negative pressure of WC	N/A
Maximum positive pressure of WC	12"
Length	8"

Available connection sizes

3/4" Clear



PCC-V11B-NO

1" Clear



PCC-V22B-NO

1-1/4" Clear



PCC-V33B-NO

1-1/2" Clear



PCC-V44B-NO

3/4" White



PCE-V11B-NO

1" White



PCE-V22B-NO

1-1/4" White



PCE-V33B-NO

1-1/2" White



PCE-V44B-NO

Flammability rating: UL94 V-0
 Condensate flow data (GPM): Page 5

Air leak data: Page 47
 P-Series Key Drawing: Page 25

P-Series Operation

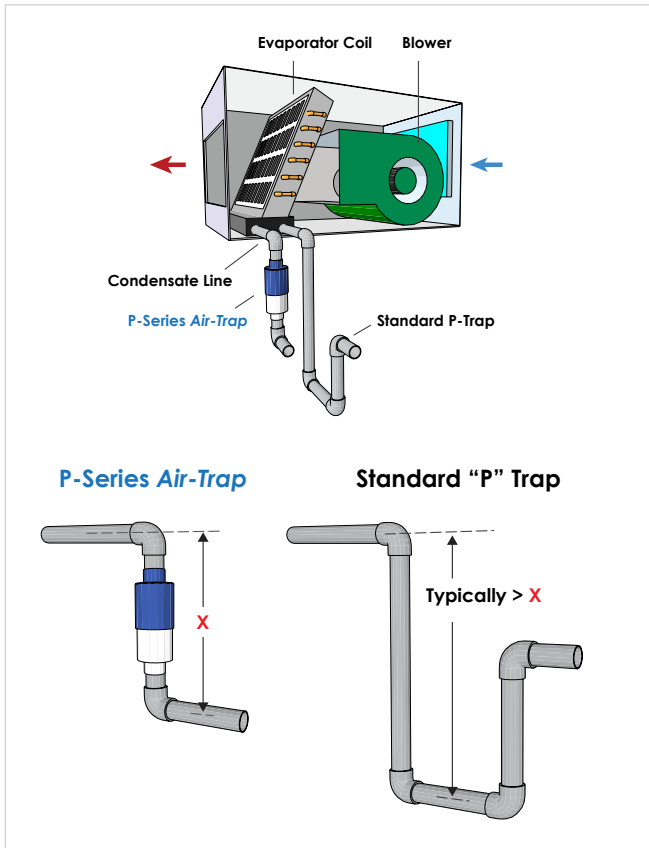

When condensate **IS NOT** present, cylinder sets tightly against seat.

When condensate **IS** present, buoyancy moves cylinder away from seat.

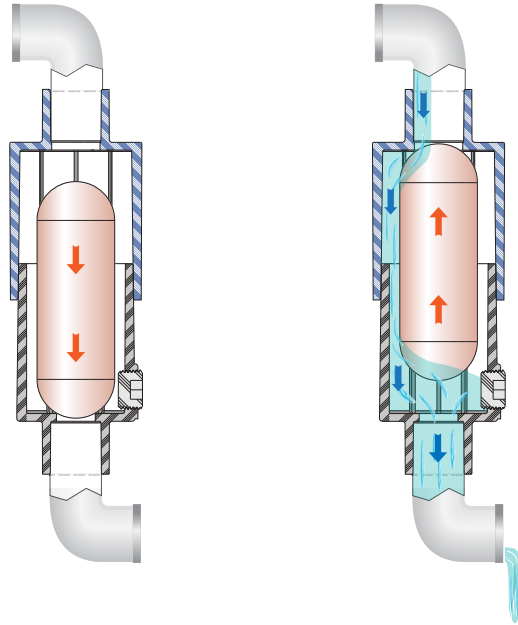

P-Series Installations



P-Series commercial positive pressure internal installation.

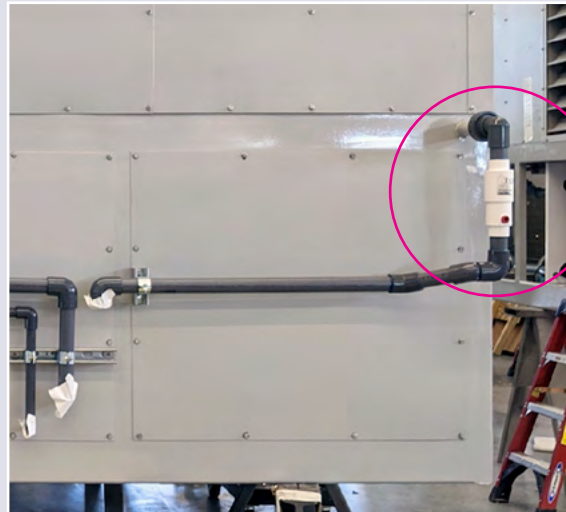

P-Series commercial positive pressure installation directly into schedule 80 PVC.



PLP-Series

Positive Pressure, Low Profile 0-40" WC Waterless Trap

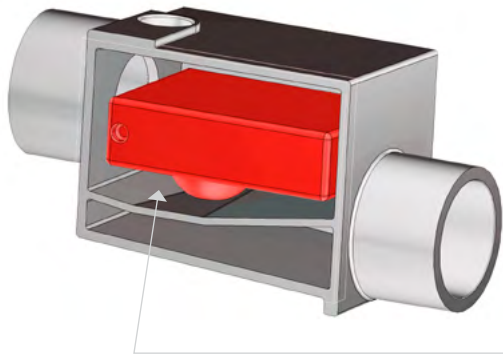

Features

- Schedule 40 PVC with clean out port
- Requires only 2-7/8" height for positive 0-40" pressure (PLP-084) and 2" for the smaller 0 to 5" WC pressure (PLP-051)
- Uses a levered, horizontal pancake designed float-valve with a mechanical advantage about a pivot point.
- Meets general building codes. For use on HVAC equipment only. Not for use as a sanitary trap.

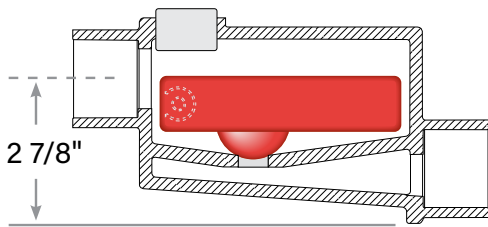

PLP-084 1-1/2"

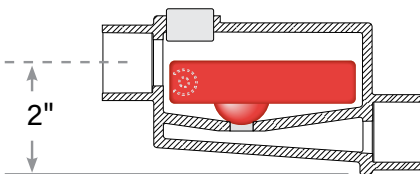

PLP-051 3/4"

Specifications

PLP-084 1-1/2"

Maximum negative pressure of WC	N/A
Maximum positive pressure of WC	0-40"
Length	7.75"

PLP-051 3/4"

Maximum negative pressure of WC	N/A
Maximum positive pressure of WC	0-5"
Length	5.6"

Available connection sizes

3/4" Clear



PLP-051 C

3/4" White



PLP-051

1-1/2" Clear



PLP-084 C

1-1/2" White



PLP-084

Flammability rating: UL94 V-0
 Condensate flow data (GPM): Page 5

Air leak data: Page 47
 PLP-Series Key Drawings: Pages 26 and 27

PLP-Series Operation

The PLP operates dry when no condensate is being produced and uses a levered, horizontal pancake designed float-valve with a mechanical advantage about a pivot point. This allows the PLP to require less than 2-7/8" inches of height for up to 40 inches WC pressure (PLP-084) instead of the 8 to 60 inches required for a standard P-Trap. 2" for the smaller 0 to 5 inches WC pressure (PLP-051)

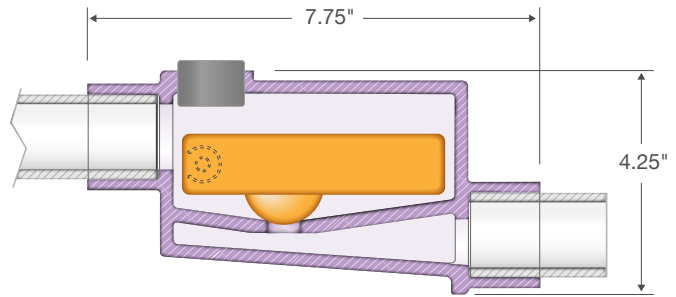

PLP-084 1-1/2" shown

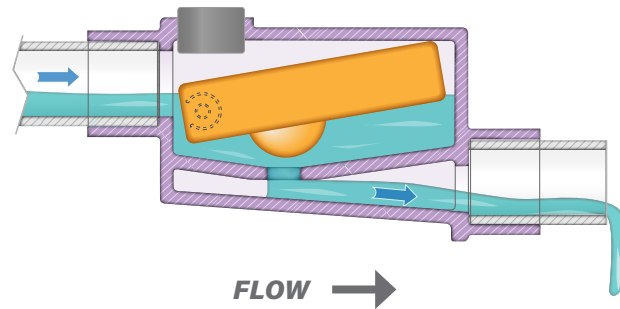

FLOW →

PLP-Series Installations

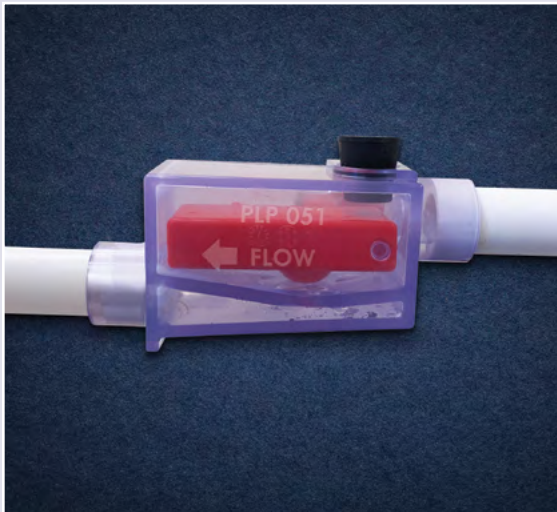

PLP-051, 3/4" positive pressure low profile Air-Trap. Only requires 1" from inlet to outlet.



PLP-084, 1-1/2" positive pressure low profile Air-Trap, with 3/4" bushing on the inlet and 2" bushing on the outlet.

PHP-Series

For Positive Pressures 12 to 100-inches WC

Features

- Trap height is less than 13-inches tall, eliminating the need for mounting the AC equipment on rails, very high curbs, cutting holes in roofs, etc.
- Schedule 40 PVC with clean out port
- Retains no water after condensing has ceased
- Requires no water head to cause trap to operate
- Meets general building codes. For use on HVAC equipment only. Not for use as a sanitary trap.

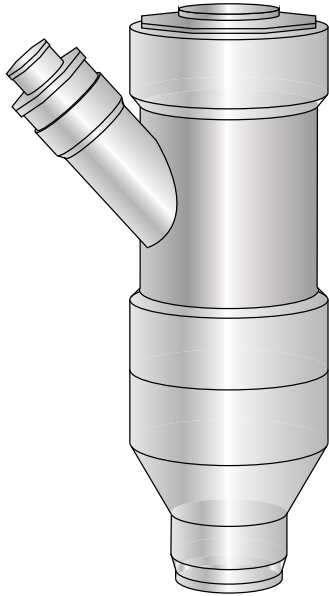

PHP 50-Series Air-Trap

Specifications

PHP-50

Maximum positive pressure of WC: 0-50"

Dimensions: 12" H x 5" Diameter

PHP-100

Maximum positive pressure of WC: 0-100"

Dimensions: 13" H x 6" Diameter

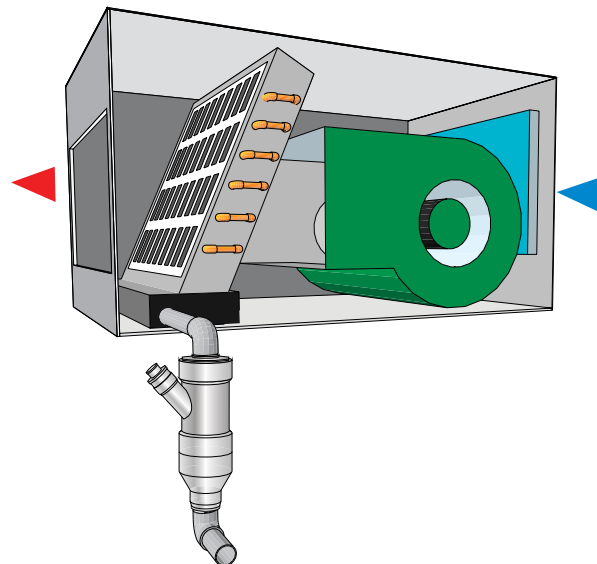



IPN Series

Condensation Removal for High Efficiency Gas Furnaces

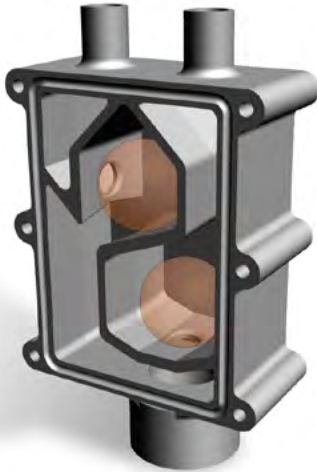

Features

The IPN-Series is specifically designed to simultaneously accommodate condensate flow from both positive and negative pressure input and deliver it to a final drain line without allowing combustion products to intermingle between high and low-pressure chambers or escape to the conditioned space. The IPN uses the pressure of the combustion gas to seal the positive and negative drains from the condensate collection chamber.

- Does not require water to seal against gas leakage
- No water within trap except during time condensing occurs, therefore no freezing
- Eliminates regular removal of accumulated sludge from bottom of trap
- Eliminates need to prime trap in spring or after a period of in use
- No geyser within drain pan resulting from air being sucked into furnace drain pan

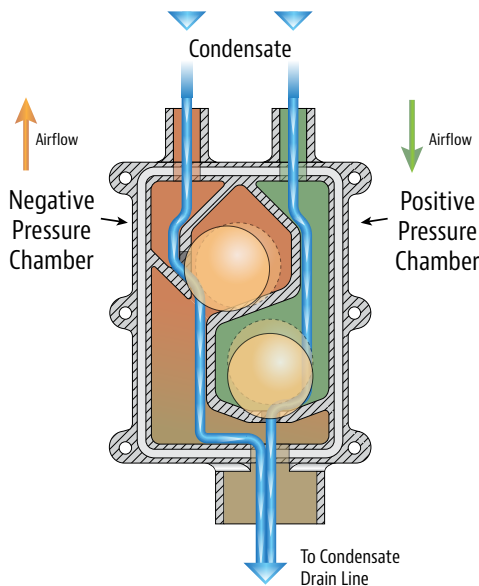

Negative Pressure Chamber

The ball valve is sucked against the seat and when condensate forms to a vertical height greater than the suction pressure in inches, the ball is then forced away from the seat and water flows from the trap.

Positive Pressure Chamber

Air pressure pushes the float ball against the seat until condensate begins to flow, at which time, the ball is buoyed and water flows.





Union-Strainers™

Unions with Built-in Strainer

Features

- Inexpensive and easy to install and service
- Install Union-Strainers upstream of the HVAC Air-Trap to prevent rocks, screws, nuts, etc. from getting into the trap mechanism
- Prevents unwanted creatures, such as snakes, rats, lizards, and insects, from entering the terminus of the drain line
- Meets general building codes. For use on HVAC equipment only. Not for use as a sanitary trap.
- Schedule 40, white PVC

Simply cap the end of the drain with a Union-Strainer. Strainer basket must be installed in the direction of water flow.

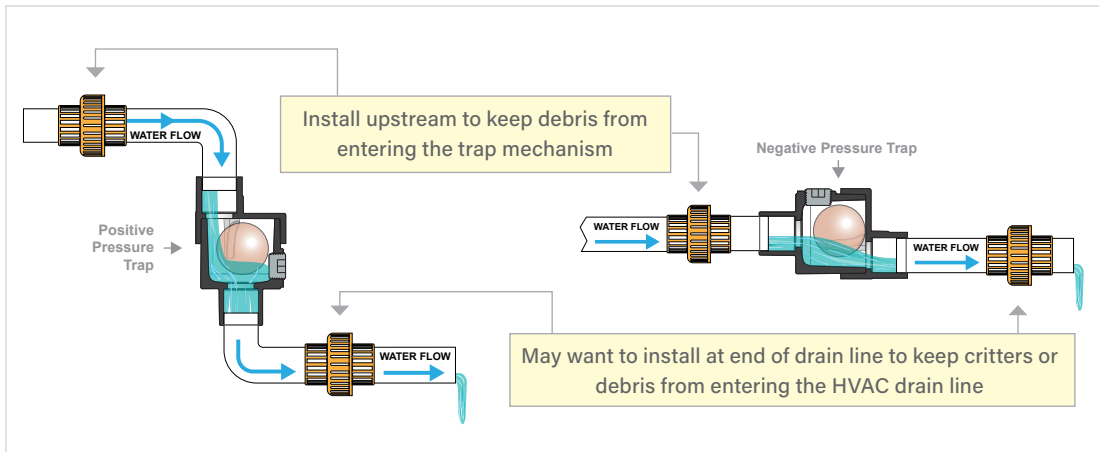

Union Strainers conjoined with a P-Series HVAC Air-Trap

Available connection sizes

3/4"



US-051

1"



US-062

1-1/4"



US-073

1-1/2"



US-084

2"



US-095

HVAC *Air-Trap*[™]

PRODUCT KEY DRAWINGS

FCN-Series Key Drawing

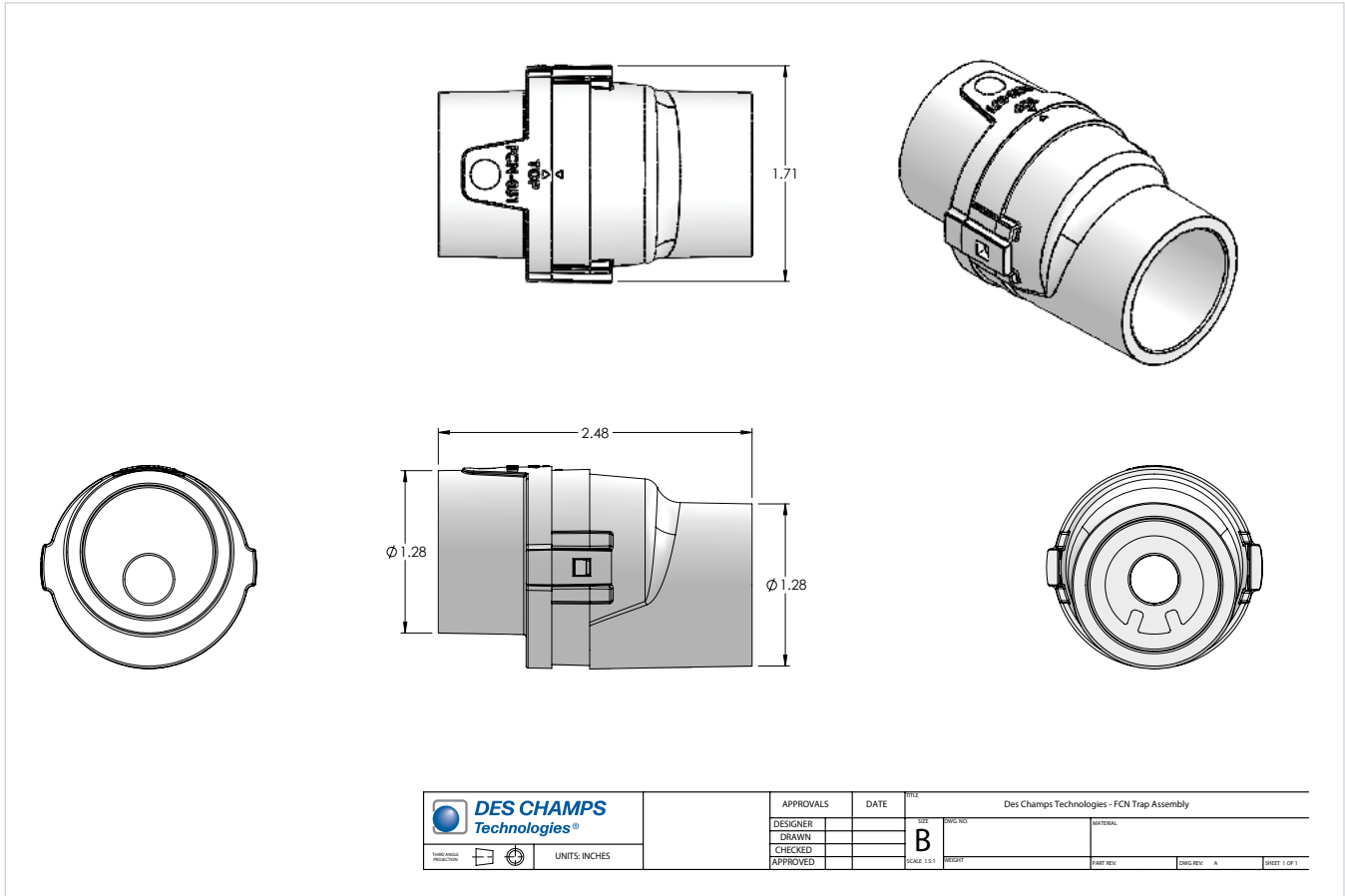

RLC-Series Key Drawing

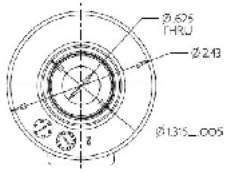

Pipe Top view

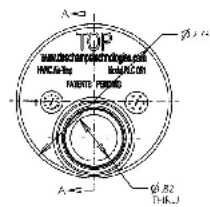

Socket Top View

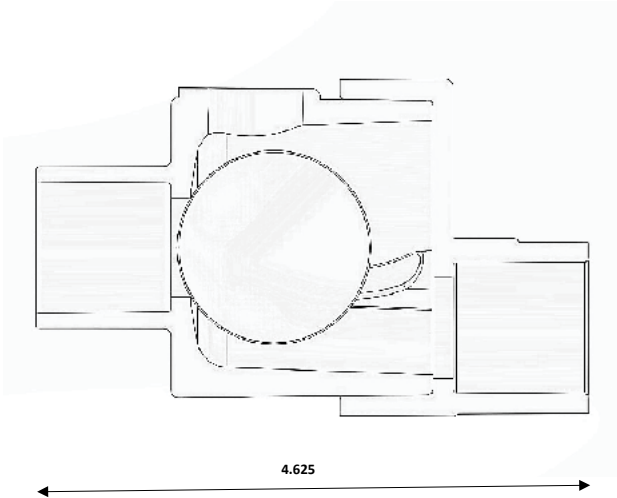

2. UNLESS OTHERWISE SPECIFIED:
 XXX - .005
 XX ± .010
 X + .020

1. MATERIAL: PVC

	Length	INCH
	RLC Series Dimension	CL 1/25/17
	Key Drawing	

N-Series Key Drawing

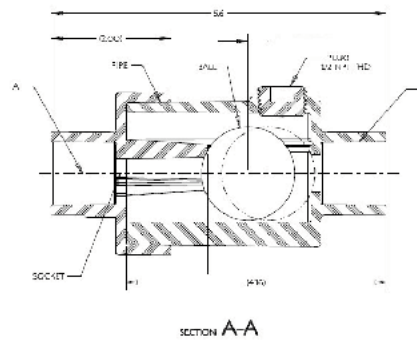
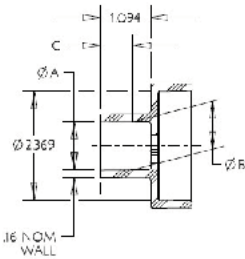
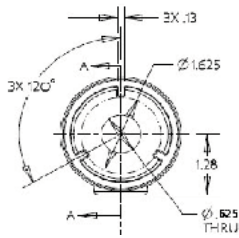

PIPE SIZE	DIA A	DIA B	DEPTH C	VOLUME IN ³
3/4	1.058	1.046	.719	2.519
1	1.425	1.410	.875	2.674
1-1/4	1.670	1.655	.998	2.965
1-1/2	1.912	1.894	1.084	3.011

3. VOLUME SEE TABLE

2. UNLESS OTHERWISE SPECIFIED:
 .XXX + .005
 .XX = .010
 .X ± .020

1. MATERIAL: SCHEDULE 40 WHITE PVC OR CLEAR PVC

	Length	INCH
N-Series Dimension Key Drawing	CL	8/1/17

P-Series Key Drawing

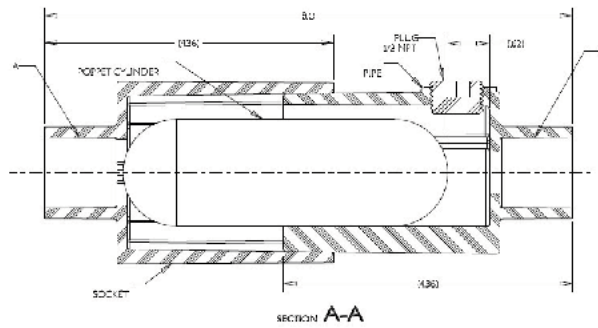
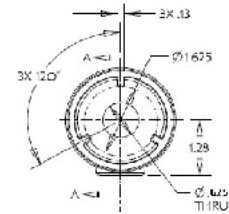
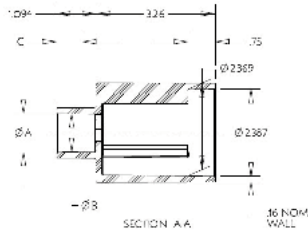

PIPE SIZE	DIA A	DIA B	DEPTH C	VOLUME IN³
3/4	1.058	1.046	.719	2.519
1	1.325	1.310	.875	2.673
1-1/4	1.670	1.655	.938	2.865
1-1/2	1.912	1.894	1.094	3.011

3. VOLUME SEE TABLE

2. UNLESS OTHERWISE SPECIFIED:
 XXX ± .005
 .XX = .010
 X = .020

1. MATERIAL: SCHEDULE 40 WHITE PVC
 OR CLEAR PVC

	Length	INCH
	P-Series Dimension Key Drawing	CL

PLP-Series 051 Key Drawing

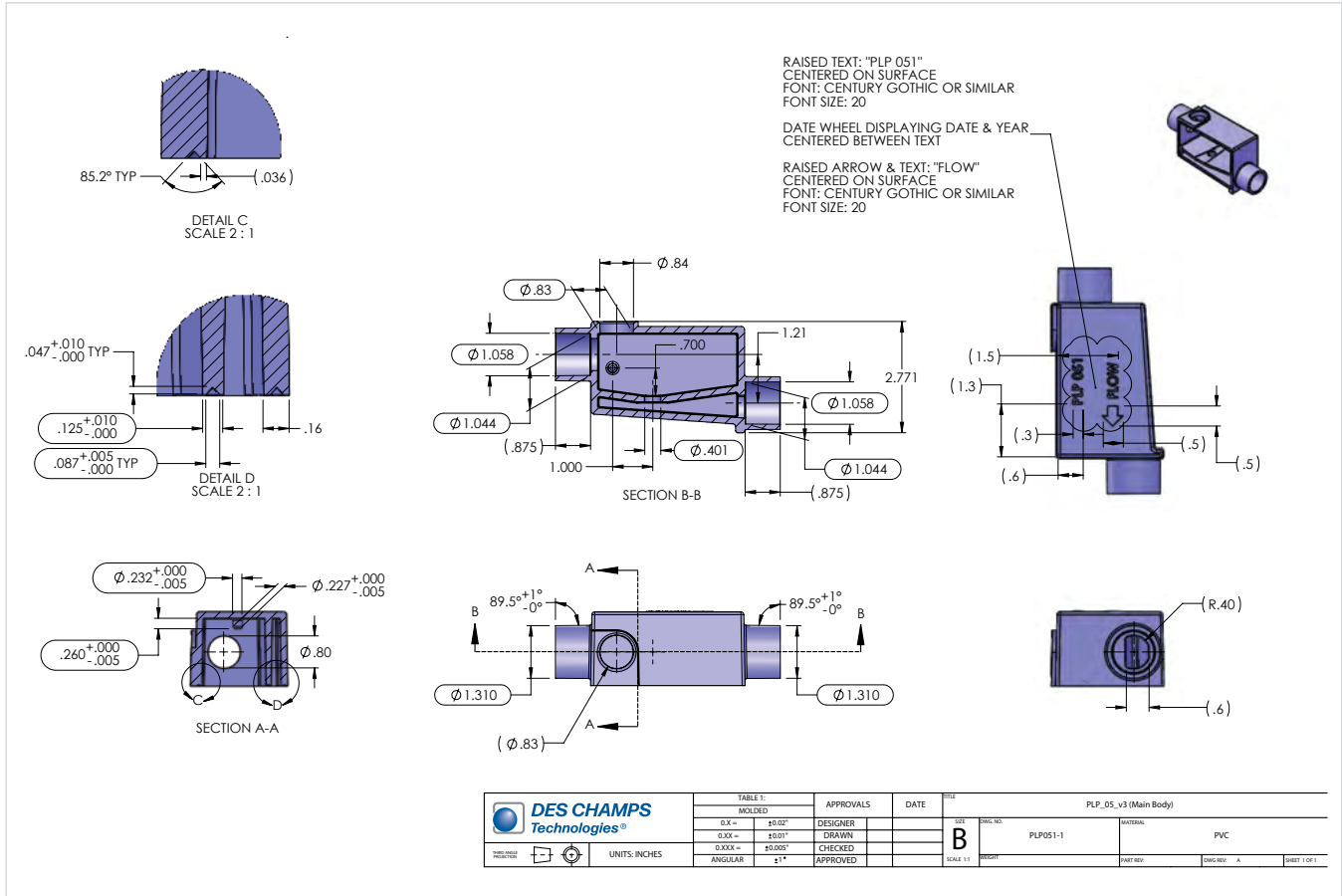

PLP-Series 084 Key Drawing

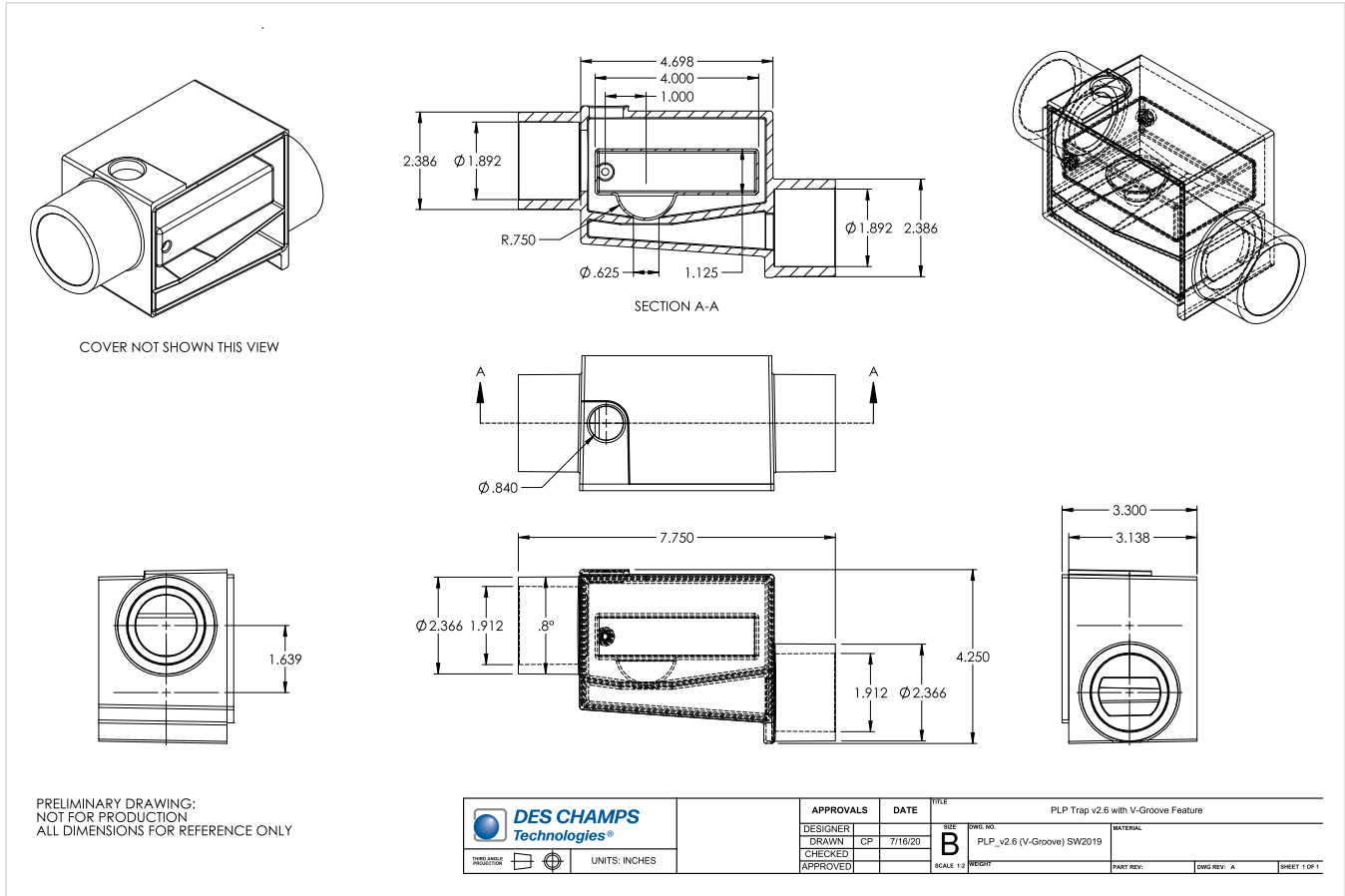

Condensate Removal from HVAC Equipment

Mechanical Specification - Condensate Trap February 8, 2022

The installer of the HVAC cooling (or Energy Recovery) equipment shall be responsible for the removal of condensate, and other possible sources of water formation, from the unit and the delivery of the water to an approved drainage system as determined by local codes or owner’s preferences, such as gray water storage or storm water drainage system. The external drain lines shall be connected to the unit by means of unit manufacturer supplied standard male pipe connections stubbed external to the unit, near the base. The drain line shall be sloped downward at a minimum of 1/8 inch per running foot in the direction of water flow away from the unit.

To prevent air from entering or leaving the HVAC unit, a condensate trap shall be placed within the water drain line that prevents air flow through the trap (and condensate drain line) but allows water to exit the unit and flow to the drainage system. Whether positive plenum pressure (fan blowing through cooling coil) or negative plenum pressure (fan drawing through cooling coil) a trap shall be installed within the drain line as near to the unit drain connection as is practicable.

The trap shall prevent any noticeable or measurable air flow from or to the HVAC unit by way of the condensate drain line at any time during the year. In addition, the drain line and trap shall:

- a) Be designed to prevent any water from remaining in the drain pan, drain line, or trap when there is no condensate being produced.
- b) Not require priming with water at initial startup or after extended period of no condensate formation.
- c) Have means to access the trap and lines for purpose of flushing debris from trap and/or condensate line.
- d) Meet standard and local building code requirements.

Air entering or leaving an HVAC unit via the condensate drain line manifests itself as an energy loss and a reduction of indoor air quality, the reason being that the replacement air must be filtered and conditioned. In addition, air drawn into a unit (which occurs often with a dry P-Trap, usually originates at undesirable locations such as gray water storage tanks or near sewer vents. As a result, the condensate line trap shall essentially never allow air to flow through the drain line.

The drain line, in addition to being properly sloped away from the unit, may require inclusion of a vent pipe. If required, the vent should be installed as close to the exit of the trap as possible. The purpose of the vent is to prevent a vacuum from developing at exit of trap which could result in a trap malfunction. All condensate piping shall be supported at intervals to maintain a straight alignment and a uniform slope as required by the Uniform Plumbing Code. Allow for thermal expansion and movement in all piping installations using approved methods. Support, but do not rigidly restrain, piping at branches or changes of direction. Do not anchor rigidly in walls. Holes through framing members shall be adequately sized to allow free movement. The below table shows a recommended condensate-line pipe size as a function of AC tonnage; however, pipe size could vary depending on local weather conditions. For instance, a 20-ton AC unit may require 1 to 1-1/4 inch diameter in South Carolina and could easily be a 3/4 inch in Las Vegas.

Size (tons)	0- 20	21-40	41-60	61-100	101-250	>250
Minimum condensate	3/4 to 1	1 to 1-1/4	1-1/4 to 1-1/2	1-1/2 to 2	2 to 3	3 or greater

Drain size (inches)

Sample Specification:

For HVAC Unit# ____ the condensate drain line shall be ____ inch diameter schedule 40 PVC and the condensate trap shall be manufactured by _____, Model _____, capable of accommodating ____ GPH of condensate at a plenum pressure of _____ inches WC positive □ negative □. Refer to Manufacturer’s instructions for installation, operation, and maintenance of the condensate trap.

Notes

RLC-Series Positive Pressure Installation



HVAC Air-Trap™

INSTALLATION, OPERATION AND MAINTENANCE MANUALS



The *Air-Trap™* concept has been incorporated into IAPMO IGC 196-2018 *Standard for Condensate Traps and Overflow Switches for Air-Conditioning Systems*.

FCN-Series: IOM

Positive Pressure Waterless Trap



This is a guide to the user of an FCN Series *Air-Trap* during installation, commissioning, operation, or periodic maintenance.

The Benefits of the FCN Air-Trap are:

- Eliminates the geyser effect that is caused when the standard P-trap dries out and condensate begins to form
- Operates dry except when condensate is being produced
- Will not freeze
- No sludge build-up in bottom of trap
- Requires less than half the height of a standard P-trap
- Easily comes apart for cleaning



DO NOT USE EXCESS CEMENT. Too much cement could interfere with ball movement and cause trap failure.

NEVER CONNECT CONDENSATE DRAIN DIRECTLY TO A SANITARY DRAIN LINE.

Standard connection is 3/4" slip. A 3/4" to 1/2" bushing can be used to accommodate a 1/2"- size PVC SCH 40 pipe.

Negative-Pressure Application

When operating with a negative pressure plenum, install the FCN *Air-Trap* in a horizontal orientation with the "FLOW" arrowhead pointing in the direction of water flow as shown in **Figure 1**. The direction of condensate flow is indicated on the larger of the two tabs that clamp together the two parts of the trap.

Condensate enters the end of the trap with the 3/8" diameter hole and the word "TOP" is molded into the inlet end of the FCN as shown in **Figure 2**.

When disassembling the FCN for maintenance, use a small flat head screwdriver and lightly, and slowly, pry the wider tab outward a few thousandth of an inch until the two parts separate. There should be no maintenance required other than cleaning. Reassembling requires that the O-ring be properly placed in the groove and the ball-valve be properly positioned as shown in **Figure 3**.

Figure 4. Installation of the FCN for negative pressure showing arrowhead pointing in direction of water flow.

FCN traps are rated at up to 1 GPM of condensate flow at essentially any negative pressure, but H (refer to **Figure 4**) increases linearly with pressure.

Figure 5. FCN with integral 3/4" slip connections

There are two clips that connect the two parts of the trap, one clip is wider than the other, so make sure to match wide to wide and narrow to narrow.

Figure 1

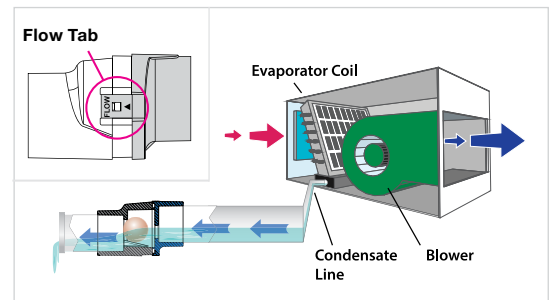

Figure 2

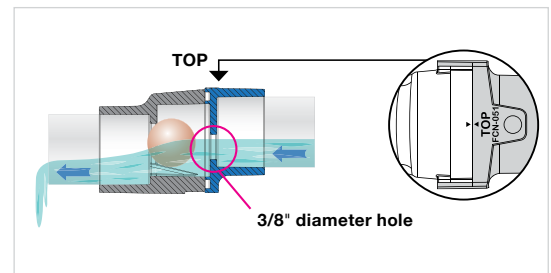

Figure 3

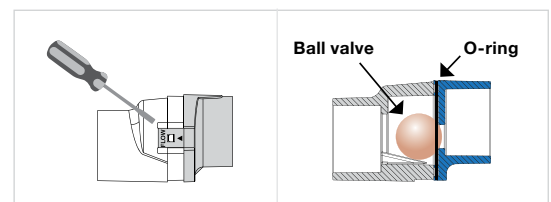
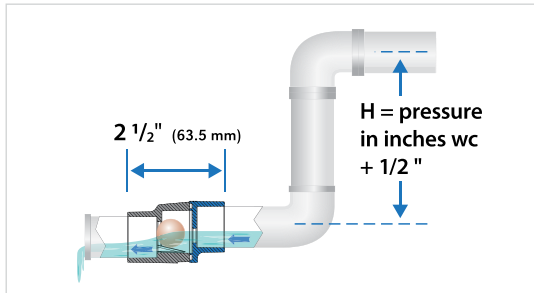

Figure 4



Positive-Pressure Application - Up to 0.5 inches WC

When using an FCN Air-Trap for positive pressure it is installed in a vertical position with the top arrow, ▲, pointing upward, in such a manner that the float valve is resting on top of the circular seat. See Figure 6.

Note on Installation:

The design of the FCN Air-Trap is a result of customers requesting a small, compact, easily serviceable trap for fan-coil and residential air-conditioning equipment. For ease of service we decided to use integral latches to allow the trap to be easily taken apart for cleaning. This assembly method works great for its intended application. Two conditions may exist after installation that could exert extreme force on the trap that cause the FCN to come apart:

- 1) If the drain line on the leaving side of the trap is rather long and rigidly supported near the end then thermal contraction of the condensate line could exert such a tension force that it will overcome the ability of the compression latches to function properly.
- 2) If the condensate line leaving the trap runs a considerable length with no support it could develop a torque acting on the trap that could overcome the ability of the latches to function properly.

If either of these conditions exist after installation, then we recommend that you place an SAE #20 (13/16" to 1-3/4" diameter by 1/2" wide) SS hose clamp around the FCN so that the clamp is over the latches and then tighten the clamp so that the latches can not be pulled from their socket. Figure 7 illustrates the position of the hose clamp relative to the trap.

Figure 5

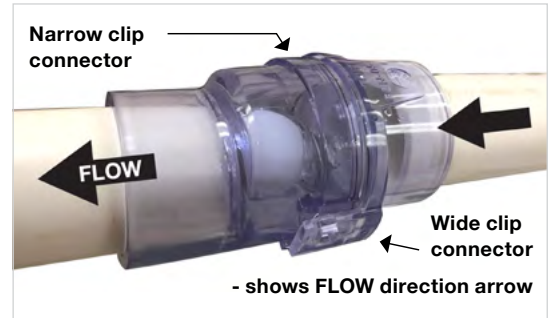

Figure 6

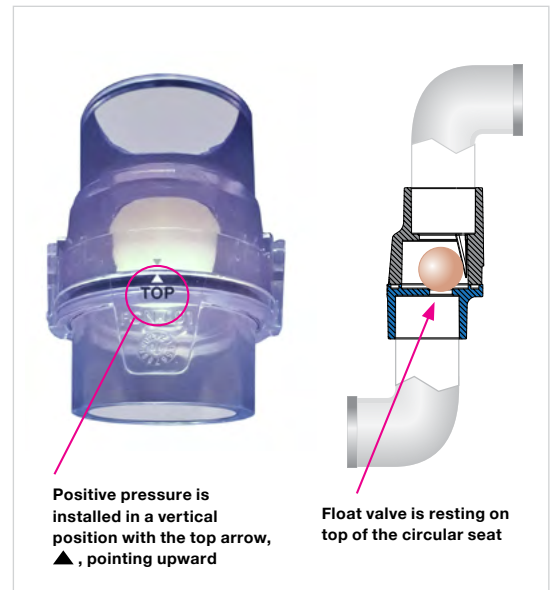
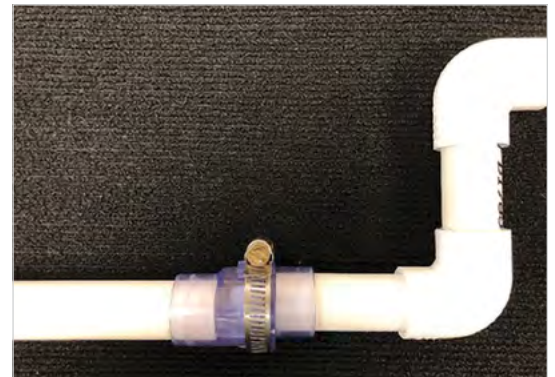

Figure 7



The Air-Trap™ concept has been incorporated into IAPMO IGC 196-2018 Standard for Condensate Traps and Overflow Switches for Air-Conditioning Systems.

RLC-Series: IOM

Positive/Negative Pressure Waterless Trap



This is a guide to the user of an RLC Series *Air-Trap* during installation, commissioning, operation, or periodic maintenance.

Product Description

The RLC-Series *Air-Trap* allows water to drain from HVAC equipment and simultaneously prevents air from escaping from or entering the equipment.

The RLC-Series *Air-Trap* does not require standing water to prevent gas (typically air) from entering or leaving the HVAC unit. With the occurrence of condensate, or other water sources within the unit, the water flows out of the HVAC unit but no gas flows past the trap. When there is no production of water, there is no water in the trap and there is no gas passing through the trap. **Install the RLC-SERIES Air-Trap in a vertical position for positive pressure and in a horizontal position for negative pressure.**



DO NOT USE EXCESS CEMENT. Too much cement could interfere with ball movement and cause trap failure.

NEVER CONNECT CONDENSATE DRAIN DIRECTLY TO A SANITARY DRAIN LINE.

DO NOT PUNCTURE FLOAT VALVE.

Positive Pressure Application

The RLC-Series maximum operating positive pressure is 3.0 inches WC. If the positive pressure is expected to be greater, then a P-Series *Air-Trap* for up to 12 inches WC or an engineered *Air-Trap* for any positive pressure above 12 inches WC should be used.

Always connect the drain line leaving the drain pan directly to a trap to ensure proper drainage of water while simultaneously preventing unwanted air from entering or leaving the HVAC equipment.

Figure 1 - Strainer screen



Failure to provide adequate drainage piping may result in water damage to equipment or building.

Important: If there is a possibility of items such as screws, gravel, etc. falling into the drain line then install a strainer screen, as shown in **Figure 1** over the drain inlet prior to operation of the HVAC unit and before installing the trap. An integral Union-Strainer (also available from Des Champs Technologies LLC, see **Figure 5**) may also be inserted in the drain line upstream of the *Air-Trap*.

Figure 2 - RLC-Series Air-Trap installed vertically for positive pressure application

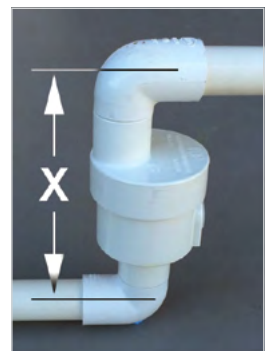

1. Install the RLC-Series *Air-Trap* vertically with the embossed arrowhead ▲ pointing upward (see **Figure 4**). This is a requirement for proper movement of the internal float valve component.
2. Install the trap in accordance with manufacturer's instructions and with all applicable local or national plumbing, drainage, and mechanical codes.
3. NEVER CONNECT CONDENSATE DRAIN DIRECTLY TO A SANITARY DRAIN LINE.
4. Connect only to a storm drain or a condensate drain line. This product is to control flow of condensate produced by HVAC equipment and is not to be used on kitchen sinks, showers, or in any application where a fan is not creating a negative or positive pressure.

Operation in Vertical, Positive Pressure Mode

The RLC Air-Trap operates dry when no water removal is required and wet when it is required. When dry, essentially no air exits the HVAC unit. When removing water, the water exits the unit, but essentially no air exits the unit through the drain connection.

Install the Air-Trap in a vertical orientation. With no production of condensate within the AHU, the positive pressure that exists within the unit plenum that contains the drain line forces the ball valve downward onto the valve seat. With the production of water, the ball rises from the seat when the net buoyancy force upward equals or exceeds the net downward force created by air pressure. See view in **Figure 3**.

The RLC Series Air-Trap accomplishes the following:

- Reduces sludge buildup that normally accumulates in standard P-traps
- Prevents freezing of trap during cold periods since during periods of no water removal there is no water in the trap. If, for some reason, water is flowing from the unit during freezing temperatures, and the trap is located within this freezing temperature region, then the trap will require thermal protection.
- RLC-Series Air-Trap requires no water head to cause the trap to operate. Simply come out of the plenum with the condensate line and go down into the Air-Trap. Come out of the trap and go horizontally with your drain line. The height, X, requirement then becomes the height of the trap plus two street elbows which totals 6 inches. See **Figure 2**.
- Eliminates air escaping from an HVAC unit that would result when a standard P-Trap experiences a "dry-out" condition.
- Note: If there is a possibility of a syphoning effect (suction pressure) at the exit point of the Air-Trap then it is necessary to install a vertical vent pipe as close as possible to the bottom of the trap (see **Figure 4**).

Maintenance and Techniques for Cleaning the RLC Air-Trap

Preventative Maintenance

In some operations, large particulate matter can move from the HVAC unit through the drain line and into the Air-Trap, causing a malfunction or failure. The best way to reduce maintenance is to install a strainer screen at the inlet to the drain line (**Figure 1**) or a Des Champs Union-Strainer™ upstream of the Air-Trap, (See **Figure 5**) to prevent miscellaneous items like, rocks, screws, and nuts from ever getting into the trap. The Union-Strainer is also a convenient way to prevent unwanted creatures and objects from entering at the terminus of the drain line, like snakes, rats, lizards, insects, and plant growth. The water flow is in direction of arrow shown in **Figure 5**, with the strainer cup oriented to capture debris within the cup.

Figure 3 - RLC Air-Trap - up to 3 inches of positive pressure at ½ gallon per minute of condensate flow

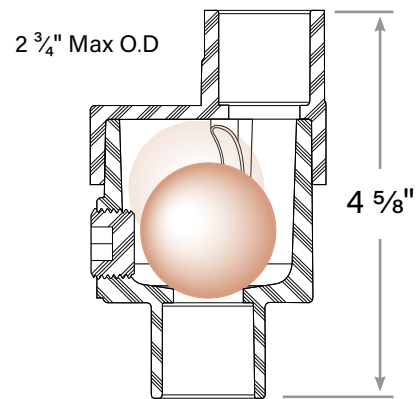

Positive pressure orientation

Figure 4 - Installation of a Vertical Vent Pipe installed directly downstream of a positive pressure trap to prevent a suction pressure that could develop depending upon the length of drainpipe, the diameter, and the water flow rate.



Figure 5 - In-line Union-Strainers. Install in the drain line upstream of the Air-Trap. This will aid in preventing debris from entering trap. The arrow shows the direction of water flow, into the strainer basket.

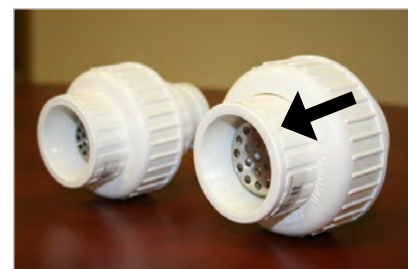

There are several options for cleaning. Option 1 is to use the 1/2 inch threaded cleanout port in the trap housing. This will allow insertion of a water or air hose/syringe for washing or blowing away material that may be hampering operation of the trap. See **Figure 3**.

Option 2 would be to isolate the *Air-Trap* using unions that allow *Air-Trap* removal for cleaning.

Negative Pressure Application

When operating with a negative pressure plenum, install the RLC *Air-Trap* in a horizontal orientation with the arrowhead ▲ pointing in the direction of water flow and the clean out plug facing upward as shown in **Figure 6**. Condensate enters the end of the trap with the centered connection and leaves the trap that has the off center connection.

The benefits and maintenance of the RLC *Air-Trap* when used in the negative pressure mode are the same as for the positive mode with the added benefit that it eliminates the geyser effect that is caused when the standard P-Trap dries out and condensate begins to form. The geyser effect is when air rushes into the HVAC unit and does not allow the condensate to drain, causing water to blow throughout the plenum compartment. In addition, the RLC negative *Air-Trap* requires less than half the height of a P-Trap. Dimension **Y** in **Figure 6** illustrates that the total height of the *Air-Trap* is only the height of the negative pressure plus one inch and not 2 times negative pressure plus two inches. Dimension **Y** in inches is = negative pressure in inches of water column.

Limited Warranty

Des Champs Technologies warrants to the original consumer purchaser ("Purchaser") of its product, RLC Series *Air-Trap*, that it is free from defects in material or workmanship. If within the 12-month period from the date of the original consumer purchase this product shall prove to be defective, it shall be repaired or replaced at Des Champs Technologies option. Your original receipt of purchase is required to determine warranty eligibility. The warranty does not cover damage due to misuse, misapplication, lack of maintenance, or failure to comply with the manufacturer's installation instructions or recommendations or any other loss or damage exceeding the purchase price of the equipment purchased from Des Champs Technologies or its appointed distributors. Des Champs Technologies assumes no responsibility for damage or injury resulting from chemical incompatibility between its products and the process fluids to which they are subjected. This warranty is limited to repair or replacement of the RLC *Air-Trap* only and is the only warranty issued by Des Champs Technologies on its trap products.

This product design is Patented by Des Champs Technologies, LLC, Natural Bridge Station, Virginia 24579.

Des Champs Technologies has other standard models of traps as well as engineered traps for high temperature, high pressure, and very high water flows. Call 1-540-228-1967 or go to the www.deschampstechnologies.com for more information.

Figure 6 - Installation of the RLC for negative pressure showing arrowhead pointing in direction of water flow. RLC traps tested at 1.6 GPM of condensate flow.

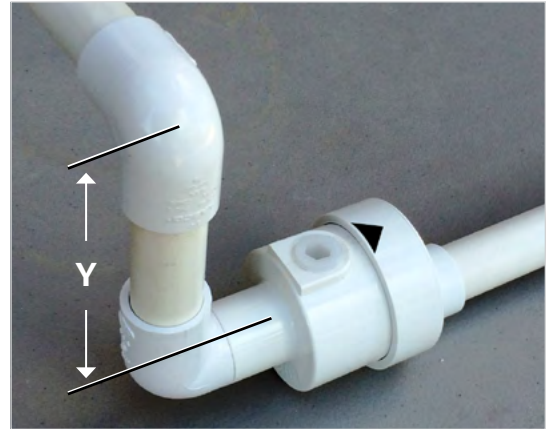
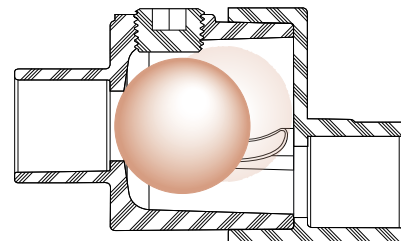
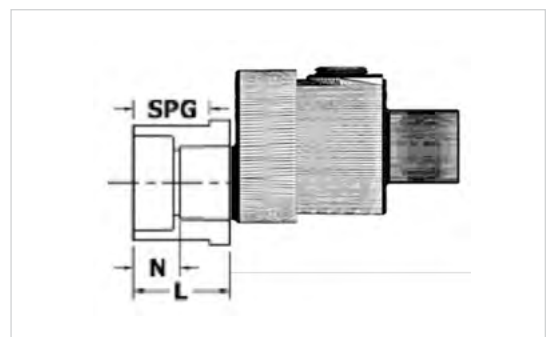

Figure 7 - Orientation for negative pressure after installation of RLC *Air-Trap*, showing cleanout port on top, condensate entering at left end center, and exiting at lowest point of trap on the right side. No water remains in trap shortly after condensation ceases.



Negative pressure orientation

Figure 8 - The standard connection is 3/4" slip. The O.D. of the connection accommodates a 1-inch bushing. Therefore, any size PVC SCH 40 pipe from 1/2 to 2 inches connects with the aid of a bushing.



The *Air-Trap*™ concept has been incorporated into IAPMO IGC 196-2018 *Standard for Condensate Traps and Overflow Switches for Air-Conditioning Systems*.

N-Series: IOM

Negative or Positive Pressure Waterless Trap

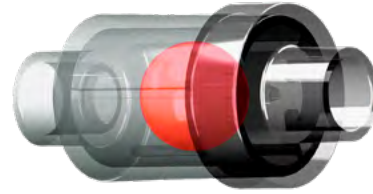

This is a guide to the user of an N-Series *Air-Trap* during installation, commissioning, operation, or periodic maintenance.

Product Description

The N-Series *Air-Trap* allows water to drain from HVAC equipment and simultaneously prevent air from entering the equipment.

The N-Series *Air-Trap* does not require standing water to prevent gas (typically air) from entering the HVAC equipment. With the occurrence of condensate or other water sources within the unit, the water flows out of the HVAC unit but no gas enters. When there is no production of condensate or water there is no water in the trap and there is no gas entering through the trap. **Install the N-Series Air-Trap in a horizontal position.**



DO NOT USE EXCESS CEMENT.

Too much cement could interfere with ball movement and cause trap failure.

NEVER CONNECT CONDENSATE DRAIN DIRECTLY TO A SANITARY DRAIN LINE.

DO NOT PUNCTURE FLOAT VALVE.

Figure 1 - Strainer screen



Failure to provide adequate drainage piping may result in water damage to equipment or building.

Important: Make sure a strainer screen, as shown in **Figure 1**, is placed over the drain inlet prior to operation of the HVAC unit and before installing the trap. An integral *Union-Strainer™* may also be inserted in the drain line upstream of the *Air-Trap* as shown in **Figure 5**.

Negative Pressure Installation

For negative pressure cooling section(s), always connect the drain pan directly to a trap to ensure proper drainage of condensate while simultaneously preventing escape of air from the unit.

1. Install the N-Series *Air-Trap* as shown in **Figure 2**. The trap has to be installed level in a horizontal plane with the **arrowhead ► in the direction of water flow**. The vertical distance **X** must be at a minimum equal to the negative plenum pressure in inches of water column. This is a requirement for proper movement of the internal components. **Figure 2** illustrates a 2-inch negative pressure condition.
2. Trap must be installed horizontally only for negative plenum pressure systems. **DO NOT INSTALL VERTICALLY.**
3. The trap must be installed in accordance with manufacturer's instructions and with all applicable local or national plumbing, drainage and mechanical codes. **NEVER CONNECT CONDENSATE DRAIN DIRECTLY TO A SANITARY DRAIN LINE.**

Operation

The N-Series *Air-Trap* operates dry when no water removal is required and wet when it is required. When dry, essentially no air flows into the HVAC unit. When removing water, the water exits the unit but essentially no air flows into the unit through the drain connection.

One of the principal advantages of the N-Series *Air-Trap* is that it operates in a horizontal position. This allows the centerline distance between the unit drain connection and the trap to be approximately the same as the negative pressure in inches of water column within the negative pressure plenum. See **Figure 2**.

When there is no water to remove the negative pressure within the plenum draws the internal valve against the valve seat and essentially no air enters the AHU through the drainpipe. When condensate forms then water builds up in the vertical pipe. When the water level equals the negative air pressure, in inches of water column, the force of the water head becomes equal or greater than the negative pressure, the internal valve moves to the right and water flows, as shown in **Figure 2**. When there is no requirement to remove water then the negative pressure returns the internal valve to the valve seat and prevents airflow to the unit plenum. The internal rails aid in returning the internal valve to the seat, especially when a variable speed fan is operating at a low flow and low negative pressure.

The N-Series *Air-Trap* will allow flow of greater than 3 GPM with no external drainpipe restrictions. **Figure 2** illustrates the distance between the unit drain connection and the centerline of the *Air-Trap* is approximately half the requirement of a standard P-trap. Therefore, use of the N-Series *Air-Trap* could be of a great advantage if the height from the AHU drain to the floor or roof is less than required by a conventional "P" Trap.

Positive Pressure Installation

Install the *Air-Trap* in a vertical orientation. With no production of condensate within the AHU, the positive pressure that exists within the unit plenum that contains the drain line forces the ball valve downward onto the valve seat. With the production of water, the ball rises from the seat when the net buoyancy force upward equals or exceeds the net downward force created by air pressure. See view in **Figure 3**.

The N-Series *Air-Trap* accomplishes the following:

- Reduces sludge buildup that normally accumulates in standard "P" trap
- Prevents water blow out when condensate begins to form at the beginning of cooling season when trap has dried and air is rushing into HVAC unit plenum, causing water spray into fan plenum compartment
- Since there is no water in the trap, there is no chance of freezing during cold periods.
- Reduces the trap height by approximately 50% as compared to the "P" trap

Figure 2 - N-Series Air-Trap negative pressure installation

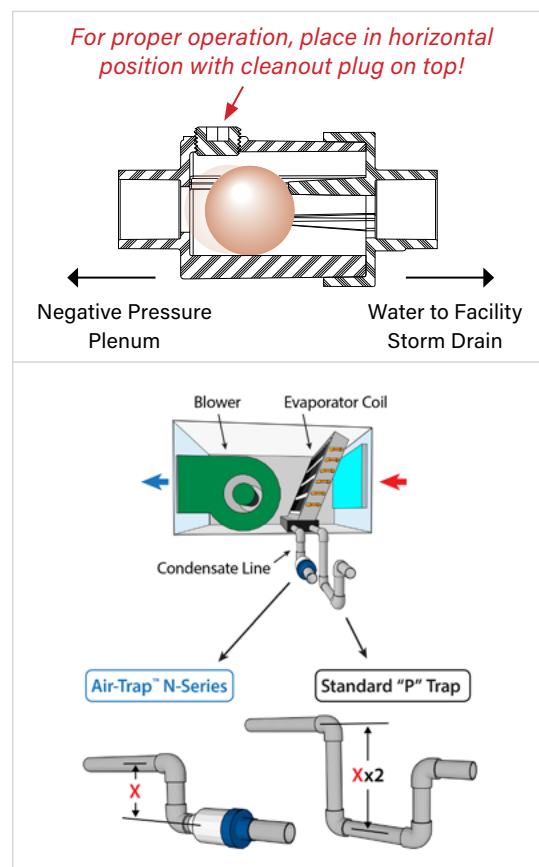
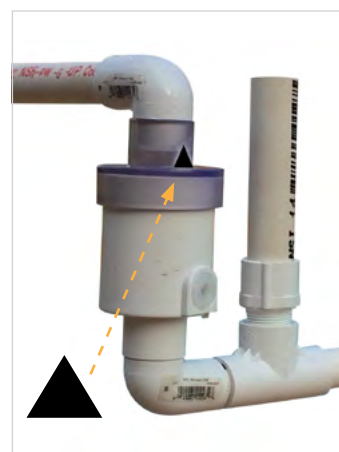

Figure 3 - N-Series Air-Trap positive pressure orientation is vertical



The *Air-Trap*™ concept has been incorporated into IAPMO IGC 196-2018 *Standard for Condensate Traps and Overflow Switches for Air-Conditioning Systems*.

Techniques for Cleaning the N-Series Trap

In some operations, particulate matter may move from the HVAC unit through the drain line and into the N-Series *Air-Trap*. The accumulation of particulate matter in the trap may potentially cause the trap to operate less efficiently or fail. Therefore, a means to remove the debris is required. A stainless steel filter screen over the drain inlet or a *Union-Strainer™* within the drain line and upstream of the *Air-Trap* extends the time between maintenance but more than likely the time will come.

There are several options for cleaning. Option 1 is to use the 1/2 inch cleanout port in the trap housing. This will allow insertion of a water or air hose for washing or blowing away material that may be hampering operation of the trap. See **Figure 2**

Option 2, shown in **Figure 4**, is to isolate the N-Series *Air-Trap* from the main drain line by installing unions that allow *Air-Trap* removal for replacement or cleaning.

The best way to reduce maintenance is to install a Des Champs *Union-Strainer* upstream of the *Air-Trap* (See **Figure 5**). The DCT *Union-Strainer* is also a convenient way to prevent unwanted creatures from entering the terminus of the drain line, like snakes, rats, lizards, and insects.

The water flow is in direction of arrow shown in **Figure 5**, with the strainer cup oriented to capture debris within the cup.

Maintenance

Inspect the N-Series *Air-Trap* on an annual basis; remove any sludge or foreign materials that might obstruct proper operation of the valve contained within the trap or general drainage of the drain line. Remove obstacles utilizing the clean out port located on the top of the *Air-Trap* or in the drainpipe. Caution - do not damage the internal valve inside the N-Series *Air-Trap*. Properly dispose of any contaminated materials.

Limited Warranty

Des Champs Technologies warrants to the original consumer purchaser ("Purchaser") of its product, the N-Series *Air-Trap*, that it is free from defects in material or workmanship. If within the 12-month period from the date of the original consumer purchase this product shall prove to be defective, it shall be repaired or replaced at Des Champs Technologies' option. Your original receipt of purchase is required to determine warranty eligibility. The warranty does not cover damage due to misuse, misapplication, lack of maintenance, or failure to comply with the manufacturer's installation instructions or recommendations or any other loss or damage exceeding the purchase price of the equipment purchased from Des Champs Technologies. Des Champs Technologies assumes no responsibility for damage or injury resulting from chemical incompatibility between its products and the process fluids to which they are subjected. This warranty is limited to repair or replacement of the N-Series *Air-Trap* only and is the only warranty issued by Des Champs Technologies on its trap products.

This product design is Patent Pending by Des Champs Technologies, LLC, Natural Bridge Station, Virginia 24579.

Des Champs Technologies has other standard models of traps as well as engineered traps for high temperature, high pressure, and very high water flows. Call 1-540-228-1967 or go to the www.deschampstechnologies.com for more information.

Figure 4 - N-Series Air-Trap with Unions



Figure 5 - Des Champs Union Strainers

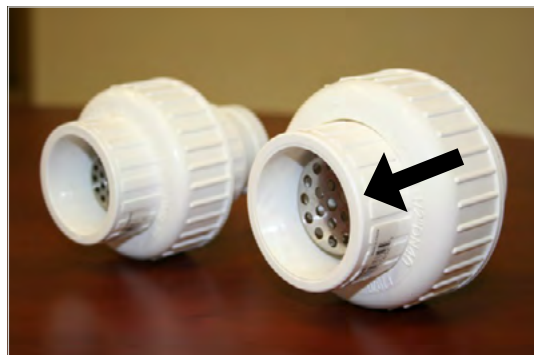

P-Series: IOM

Positive Plenum Pressure Waterless Trap

This is a guide to the user of an P-Series *Air-Trap* during installation, commissioning, operation, or periodic maintenance.



Product Description

The P-Series *Air-Trap* allows water to drain from HVAC equipment and simultaneously prevents air from escaping from the equipment.

The P-Series *Air-Trap* does not require standing water to prevent gas (typically air) from leaving the HVAC unit. With the occurrence of condensate, or other water sources within the unit, the water flows out of the HVAC unit but no gas escapes. When there is no production of condensate or water, there is no water in the trap and there is no gas leaving through the trap. **Install the P-Series Air-Trap in a vertical position.**



DO NOT USE EXCESS CEMENT.

Too much cement could interfere with ball movement and cause trap failure.

NEVER CONNECT CONDENSATE DRAIN DIRECTLY TO A SANITARY DRAIN LINE.

DO NOT PUNCTURE FLOAT VALVE.



Failure to provide adequate drainage piping may result in water damage to equipment or building.

Important: Make sure a strainer screen, as shown in **Figure 1**, is placed over the drain inlet prior to operation of the HVAC unit and before installing the trap. An integral *Union-Strainer™* may also be inserted in the drain line upstream of the *Air-Trap* as shown in **Figure 8**.

Figure 1 - Strainer screen



Figure 2 - P-Series Air-Trap Installation

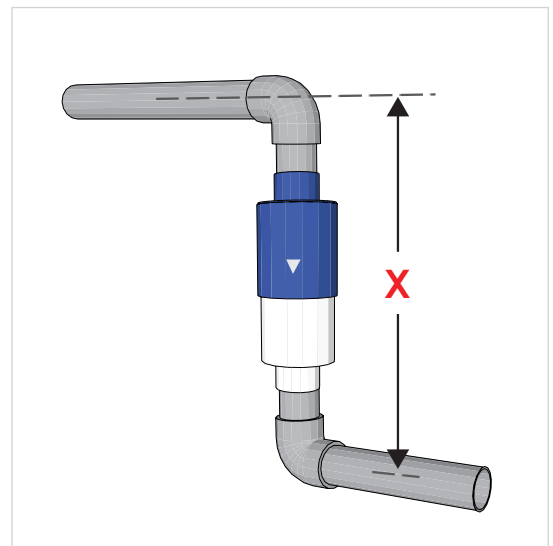

Installation

For positive pressure cooling section(s), always connect the drain pan directly to a trap to ensure proper drainage of condensate while simultaneously preventing escape of air from the unit.

1. Install the P-Series *Air-Trap* vertically with the end marked "top" facing upward and the embossed arrowhead, ▼, pointing downward (**Figure 2**). This is a requirement for proper movement of the internal float valve component.
2. Install the trap in accordance with manufacturer's instructions and with all applicable local or national plumbing, drainage, and mechanical codes.
3. NEVER CONNECT CONDENSATE DRAIN DIRECTLY TO A SANITARY DRAIN LINE. Connect only to a storm drain or a condensate drain line.

Operation

The P-Series *Air-Trap* operates dry when no water removal is required and wet when it is required. When dry, essentially no air exits the HVAC unit. When removing water, the water exits the unit, but essentially no air exits the unit through the drain connection.

Install the P-Series *Air-Trap* in a vertical orientation. With no production of condensate within the AHU the positive pressure that exists within the plenum that contains the drain line forces the capsule (or spherocylinder), downward onto the valve seat. With the production of water within the plenum, the capsule rises from the seat when the net buoyancy force upward equals or exceeds the net downward force created by air pressure. See cutaway view in **Figure 3**.

The standard model P-Series operates as a positive trap up to 12 inches WG of positive pressure. If a pressure of more than 12 inches WG could occur, then please contact Des Champs Technologies for information on the Engineered P-Series *Air-Trap*.

The P-Series *Air-Trap* accomplishes the following:

- Reduces sludge buildup that normally accumulates in standard "P" traps
- Prevents freezing of trap during cold periods since during periods of no water removal there is no water in the trap. If, for some reason, water is flowing from the unit during freezing temperatures, and the trap is located within this freezing temperature region, then the trap will require thermal protection.
- P-Series *Air-Trap* requires no water head to cause the trap to operate. Simply come out of the plenum with the condensate line and go down into the P-Series *Air-Trap*. Come out of the trap and go horizontally with your drain line. The height, **X**, requirement then becomes the height of the trap plus two street elbows. See **Figure 2**.
- Eliminates air escaping from an HVAC unit that would result from a standard P-trap experiencing a "dry-out" condition.
- Note: If there is a possibility of a syphoning effect (suction pressure) at the exit point of the *Air-Trap* then it is necessary to install a vent as close as possible to the bottom of the trap (see **Figure 9**).
- If height, **X**, is an issue, the P-Series *Air-Trap* may be installed at a 45° angle, as shown in **Figure 5**. When installed at a 45° angle, the maximum positive pressure it can withstand is 5" of WG instead of 12". The reduced pressure capability is a result of a reduction in buoyancy.
- Another option when height is an issue is to install the N-Series *Air-Trap* vertically, as opposed to horizontally when used as a negative trap, shown in **Figure 6**. The maximum positive plenum pressure it can withstand is 3" of WG. The cleanout port is on the bottom when used for positive pressure.

Figure 3 - 1/2 inch cleanout port - Standard Model of P-Series *Air-Trap* up to 12" of positive pressure.

Figure 4 - 3/4 inch thread cleanout plug - Engineered Model of P-Series *Air-Trap*, for positive pressure above 12" up to 50" WG.

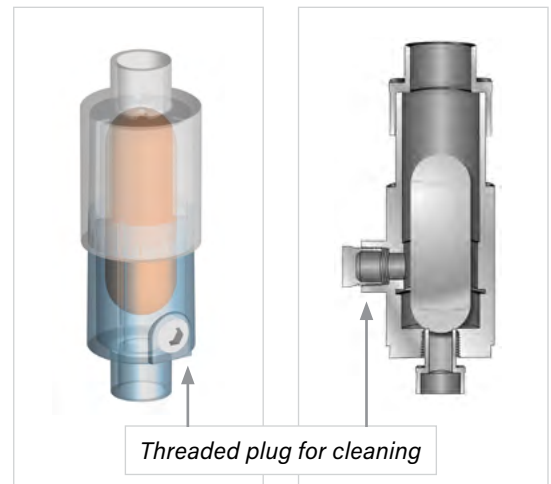

Figure 5 - P-Series *Air-Trap* installed at 45° angle can reduce trap height by 30% and operate at up to 5" of positive pressure.

Figure 6 - N-Series *Air-Trap* when installed vertically can operate properly up to 3" of positive pressure.



Maintenance and Techniques for Cleaning the P-Series Air-Trap

In some operations, particulate matter can move from the HVAC unit through the drain line and into the P-Series Air-Trap. The accumulation of particulate matter in the trap may cause the trap to operate less efficiently or fail. Therefore, a means to remove the accumulated debris is required. A stainless steel filter screen (**Figure 1**) over the drain inlet or a *Union-Strainer™* (**Figures 7 & 8**) within the drain line extends the time between maintenance. Install the Union-Strainer upstream of the Air-Trap.

There are several other options for cleaning. Option 1, is to use the 1/2 inch cleanout port in the trap housing. This will allow insertion of a water or air hose for washing or blowing away material that may be hampering operation of the trap. See **Figure 3**.

Option 2, shown in **Figure 7**, is to isolate the P-Series Air-Trap from the main drain line by installing unions that allow Air-Trap removal for replacement or cleaning.

The best way to reduce maintenance is to install a Des Champs Union-Strainer upstream of the Air-Trap, (See **Figure 8**). The Union-Strainer is also a convenient way to prevent unwanted creatures and objects from entering the terminus of the drain line, like snakes, rats, lizards, insects, and other miscellaneous items like, rocks, screws, and nuts. The water flow is in direction of arrow shown in **Figure 8**, with the strainer cup oriented to capture debris within the cup.

Des Champs Technologies also offers engineered traps for positive plenum pressure above 12 inches in WG. **Figure 4** is a cut away view of an engineered trap showing a cleanout port and the cylindrical float that rises off the seat when condensate begins to accumulate in the trap. Engineered Air-Traps are designed for applications above the 12 inches of positive pressure of the standard P-Series Air-Trap. The Engineered Air-Trap can withstand positive pressure up to 50" of WG or greater. **Caution, do not puncture the Float Valve.**

Inspect the P-Series Air-Trap on an annual basis; remove any sludge or foreign materials that might obstruct proper operation of the internal mechanism or general drainage of the drain line. Remove obstacles utilizing the clean out port located at the bottom of the Air-Trap. Caution – do not damage the internal mechanism inside the P-Series Air-Trap. Properly dispose of any contaminated materials.

Limited Warranty

Des Champs Technologies warrants to the original consumer purchaser ("Purchaser") of its product, P-Series Air-Trap, that it is free from defects in material or workmanship. If within the 12-month period from the date of the original consumer purchase this product shall prove to be defective, it shall be repaired or replaced at Des Champs Technologies option. Your original receipt of purchase is required to determine warranty eligibility. The warranty does not cover damage due to misuse, misapplication, lack of maintenance, or failure to comply with the manufacturer's installation instructions or recommendations or any other loss or damage exceeding the purchase price of the equipment purchased from Des Champs Technologies. Des Champs Technologies assumes no responsibility for damage or injury resulting from chemical incompatibility between its products and the process fluids to which they are subjected. This warranty is limited to repair or replacement of the P-Series Air-Trap only and is the only warranty issued by Des Champs Technologies on its trap products.

This product design is Patent Pending by Des Champs Technologies, LLC, Natural Bridge Station, Virginia 24579.

Des Champs Technologies has other standard models of traps as well as engineered traps for high temperature, high pressure, and very high water flows. Call 1-540-228-1967 or go to the www.deschampstechnologies.com for more information.

Figure 7 - Use unions to isolate the Air-Trap for removal or for maintenance.

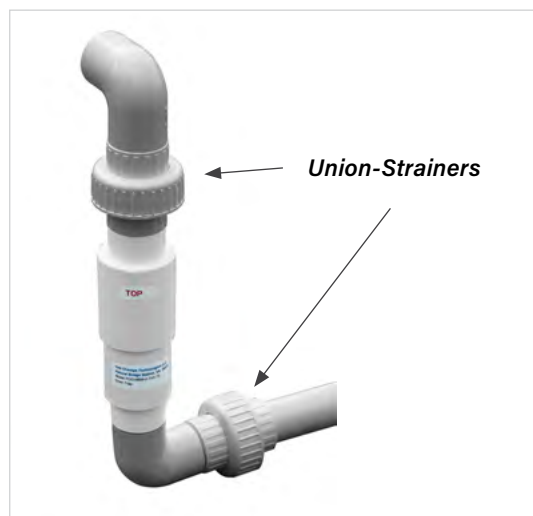
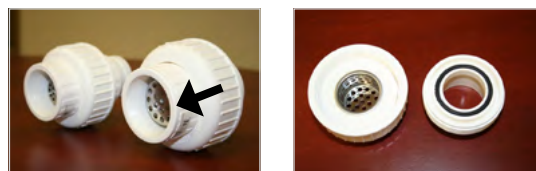

Figure 8 - Des Champs in-line Union-Strainers. Install in the drain line upstream of the Air-Trap. This will aid in preventing debris from entering trap.



The Air-Trap™ concept has been incorporated into IAPMO IGC 196-2018 Standard for Condensate Traps and Overflow Switches for Air-Conditioning Systems.

PLP-051 Series: IOM

Positive Pressures Ranging from 0 to 5" WC

These instructions are a guide to the user of a PLP-Series 051 *Air-Trap* during installation, commission into service, operation, or periodic maintenance.

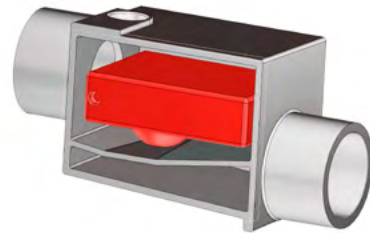

Product Description

The PLP Series *Air-Trap* allows water to drain from HVAC equipment and simultaneously prevents air from escaping from the equipment.

The PLP Series *Air-Trap* does not require standing water to prevent gas (typically air) from leaving the HVAC unit. With the occurrence of condensate, or other water sources within the unit, the water flows out of the HVAC unit but no gas escapes. When there is no production of condensate or water, there is no water in the trap and there is no gas leaving through the trap. Install the PLP Series *Air-Trap* in a horizontal position.



DO NOT USE EXCESS CEMENT. Too much cement could interfere with capsule movement and cause trap failure.

NEVER CONNECT CONDENSATE DRAIN DIRECTLY TO A SANITARY DRAIN LINE.

DO NOT PUNCTURE FLOAT VALVE.

WARNING: This product can cause expose you to chemicals including vinyl chloride, which is known to the State of California to cause cancer. For more information, go to www.P65Warnings.ca.gov

Installation

Install the PLP Series *Air-Trap* horizontally with the plug facing upward and the embossed arrowhead, ►, labeled "FLOW" pointing in the direction of water flow. This is a requirement for proper movement of the internal float valve component. PLP Series *Air-Trap* unit requires no water head to cause the trap to operate. Simply come out of the plenum with the condensate line and directly into the PLP Series *Air-Trap*. Come out of the trap and go horizontally with your drain line. See **Figure 1**. If installing with a larger or smaller pipe use a connector or bushing respectively. See **Figure 3**. Use schedule 40 bushings to accommodate smaller pipe sizes than the connections on the *Air-Trap*.

Install the trap in accordance with manufacturer's instructions and with all applicable local or national plumbing, drainage, and mechanical codes.

Operation

The PLP Series *Air-Trap* operates dry when no water removal is required and wet when it is required. When dry, essentially no air exits the HVAC unit. When removing water, the water exits the unit, but essentially no air exits the unit through the drain connection.

Install the PLP Series *Air-Trap* in a horizontal orientation. With no production of condensate within the AHU, the positive pressure that exists within the plenum that contains the drain line forces the internal mechanism downward onto the valve seat. With the production of water within the plenum, the capsule rises from the seat when the net buoyancy force upward equals or exceeds the net downward force created by air pressure. See cutaway view in **Figure 2**. Model PLP Series 051 operates as a positive trap up to 5 inches WG of positive pressure.

Figure 1

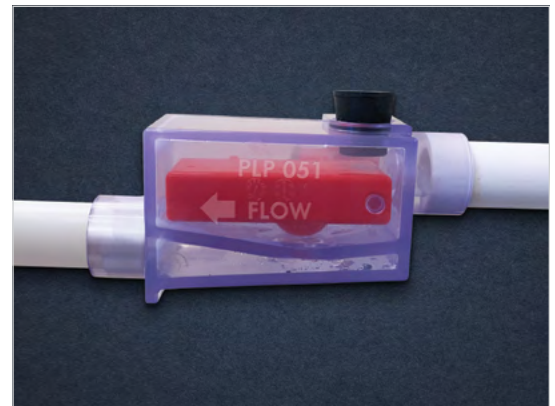

The PLP Series *Air-Trap* accomplishes the following:

- Eliminates sludge buildup that normally accumulates in standard "P" traps
- Prevents freezing of trap during cold periods since during periods of no water removal there is no water in the trap. If, for some reason, water is flowing from the unit during freezing temperatures, and the trap is located within this freezing temperature region, then the trap will require thermal protection.
- PLP Series *Air-Trap* requires no water head to cause the trap to operate.
- Eliminates air escaping from an HVAC unit that would result from a standard P-trap experiencing a "dry-out" condition.
- Reduces trap height from essentially 2 times the positive pressure (in inches WC) to 2 inches.

Maintenance and Techniques for Cleaning the PLP Series *Air-Trap*

In some operations, particulate matter can move from the HVAC unit through the drain line and into the PLP Series *Air-Trap*. The accumulation of particulate matter in the trap may cause the trap to operate less efficiently or fail. Therefore, a means to remove the accumulated debris is required.

To clean the *Air-Trap* use the 1/2 inch cleanout port in the trap housing. This will allow insertion of a water or air hose for washing or blowing away material that may be hampering operation of the trap.

Inspect the PLP Series *Air-Trap* on an annual basis; remove any foreign materials that might obstruct proper operation of the internal mechanism or general drainage of the drain line. Remove obstacles utilizing the clean out port located on the top of the *Air-Trap*. Caution – do not damage the internal mechanism inside the PLP Series *Air-Trap*. Properly dispose of any contaminated materials.

Limited Warranty

Des Champs Technologies warrants to the original consumer purchaser ("Purchaser") of its product, PLP Series *Air-Trap*, that it is free from defects in material or workmanship. If within the 12-month period from the date of the original consumer purchase this product shall prove to be defective, it shall be repaired or replaced at Des Champs Technologies option. Your original receipt of purchase is required to determine warranty eligibility. The warranty does not cover damage due to misuse, misapplication, lack of maintenance, or failure to comply with the manufacturer's installation instructions or recommendations or any other loss or damage exceeding the purchase price of the equipment purchased from Des Champs Technologies. Des Champs Technologies assumes no responsibility for damage or injury resulting from chemical incompatibility between its products and the process fluids to which they are subjected. This warranty is limited to repair or replacement of the PLP SERIES *Air-Trap* only and is the only warranty issued by Des Champs Technologies on its trap products.

This product design is Patented by Des Champs Technologies LLC, Natural Bridge Station, Virginia 24579.

Des Champs Technologies also has a full line of Commercial grade Negative Pressure Traps. Call 1-540-228-1967 or go to the following websites for more information:

www.deschampstechnologies.com -or- www.waterless-trap.com

Figure 2

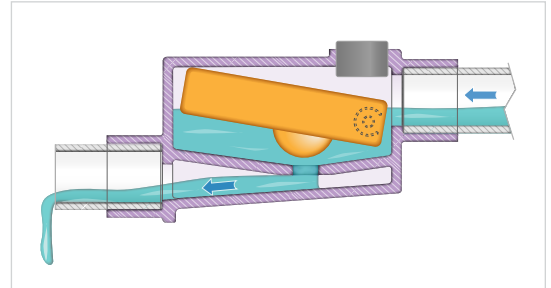
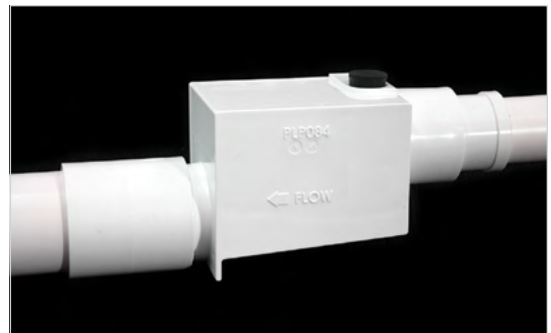

Figure 3



The *Air-Trap*™ concept has been incorporated into IAPMO IGC 196-2018 *Standard for Condensate Traps and Overflow Switches for Air-Conditioning Systems*.

PLP-084 Series: IOM

Positive Pressures Ranging from 0 to 40" WC

These instructions are a guide to the user of a PLP-Series 084 *Air-Trap* during installation, commission into service, operation, or periodic maintenance.

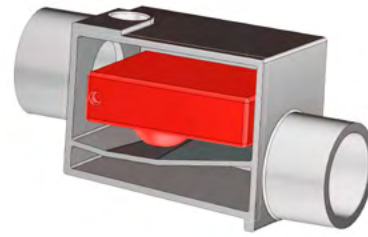

Made in
U.S.A.

Product Description

The PLP Series *Air-Trap* allows water to drain from HVAC equipment and simultaneously prevents air from escaping from the equipment.

The PLP Series *Air-Trap* does not require standing water to prevent gas (typically air) from leaving the HVAC unit. With the occurrence of condensate, or other water sources within the unit, the water flows out of the HVAC unit but no gas escapes. When there is no production of condensate or water, there is no water in the trap and there is no gas leaving through the trap. Install the PLP Series *Air-Trap* in a horizontal position.



DO NOT USE EXCESS CEMENT. Too much cement could interfere with capsule movement and cause trap failure.

NEVER CONNECT CONDENSATE DRAIN DIRECTLY TO A SANITARY DRAIN LINE.

DO NOT PUNCTURE FLOAT VALVE.

WARNING: This product can cause expose you to chemicals including vinyl chloride, which is known to the State of California to cause cancer. For more information, go to www.P65Warnings.ca.gov

Installation

Install the PLP Series *Air-Trap* horizontally with the plug facing upward and the embossed arrowhead, ►, labeled "FLOW" pointing in the direction of water flow. This is a requirement for proper movement of the internal float valve component. PLP Series *Air-Trap* unit requires no water head to cause the trap to operate. Simply come out of the plenum with the condensate line and directly into the PLP Series *Air-Trap*. Come out of the trap and go horizontally with your drain line. See **Figure 1**. If installing with a larger or smaller pipe use a connector or bushing respectively. See **Figure 3**. Use schedule 40 bushings to accommodate smaller pipe sizes than the connections on the *Air-Trap*.

Install the trap in accordance with manufacturer's instructions and with all applicable local or national plumbing, drainage, and mechanical codes.

Operation

The PLP Series *Air-Trap* operates dry when no water removal is required and wet when it is required. When dry, essentially no air exits the HVAC unit. When removing water, the water exits the unit, but essentially no air exits the unit through the drain connection.

Install the PLP Series *Air-Trap* in a horizontal orientation. With no production of condensate within the AHU, the positive pressure that exists within the plenum that contains the drain line forces the internal mechanism downward onto the valve seat. With the production of water within the plenum, the capsule rises from the seat when the net buoyancy force upward equals or exceeds the net downward force created by air pressure. See cutaway view in **Figure 2**. Model PLP Series 084 operates as a positive trap up to 40 inches WG of positive pressure.

Figure 1



The PLP Series Air-Trap accomplishes the following:

- Eliminates sludge buildup that normally accumulates in standard “P” traps
- Prevents freezing of trap during cold periods since during periods of no water removal there is no water in the trap. If, for some reason, water is flowing from the unit during freezing temperatures, and the trap is located within this freezing temperature region, then the trap will require thermal protection.
- PLP Series Air-Trap requires no water head to cause the trap to operate.
- Eliminates air escaping from an HVAC unit that would result from a standard P-trap experiencing a “dry-out” condition.
- Reduces trap height from essentially 2 times the positive pressure (in inches WC) to 2-7/8 inches.

Figure 2

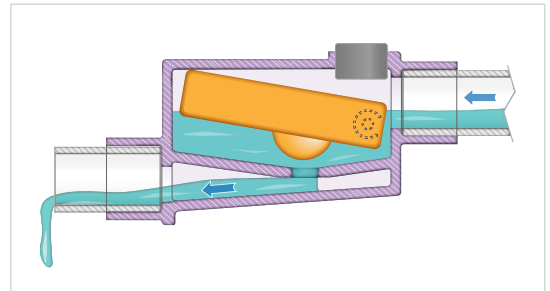

Figure 3



Maintenance and Techniques for Cleaning the PLP Series Air-Trap

In some operations, particulate matter can move from the HVAC unit through the drain line and into the PLP Series Air-Trap. The accumulation of particulate matter in the trap may cause the trap to operate less efficiently or fail. Therefore, a means to remove the accumulated debris is required.

To clean the Air-Trap use the 1/2 inch cleanout port in the trap housing. This will allow insertion of a water or air hose for washing or blowing away material that may be hampering operation of the trap.

Inspect the PLP Series Air-Trap on an annual basis; remove any foreign materials that might obstruct proper operation of the internal mechanism or general drainage of the drain line. Remove obstacles utilizing the clean out port located on the top of the Air-Trap. Caution – do not damage the internal mechanism inside the PLP Series Air-Trap. Properly dispose of any contaminated materials.

Limited Warranty

Des Champs Technologies warrants to the original consumer purchaser (“Purchaser”) of its product, PLP Series Air-Trap, that it is free from defects in material or workmanship. If within the 12-month period from the date of the original consumer purchase this product shall prove to be defective, it shall be repaired or replaced at Des Champs Technologies option. Your original receipt of purchase is required to determine warranty eligibility. The warranty does not cover damage due to misuse, misapplication, lack of maintenance, or failure to comply with the manufacturer’s installation instructions or recommendations or any other loss or damage exceeding the purchase price of the equipment purchased from Des Champs Technologies. Des Champs Technologies assumes no responsibility for damage or injury resulting from chemical incompatibility between its products and the process fluids to which they are subjected. This warranty is limited to repair or replacement of the PLP SERIES Air-Trap only and is the only warranty issued by Des Champs Technologies on its trap products.

This product design is Patented by Des Champs Technologies LLC, Natural Bridge Station, Virginia 24579.

Des Champs Technologies also has a full line of Commercial grade Negative Pressure Traps. Call 1-540-228-1967 or go to the following websites for more information:

www.deschampstechnologies.com -or- www.waterless-trap.com



The Air-Trap™ concept has been incorporated into IAPMO IGC 196-2018 Standard for Condensate Traps and Overflow Switches for Air-Conditioning Systems.

Union-Strainer: IOM



Prevents:

- Debris from entering trap mechanism
- Critters from entering drain line



These instructions are a guide to the user of a Des Champs *Union-Strainer* during installation, commission into service, operation, or periodic maintenance.

Strainer basket must be installed in the direction of water flow.

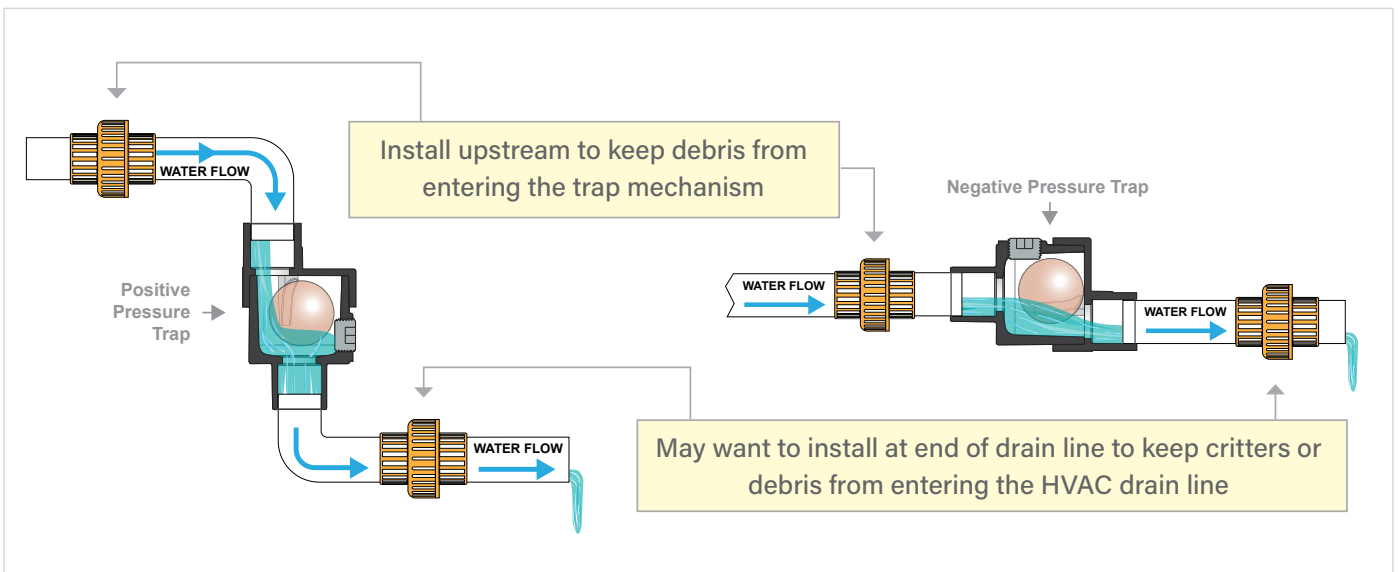
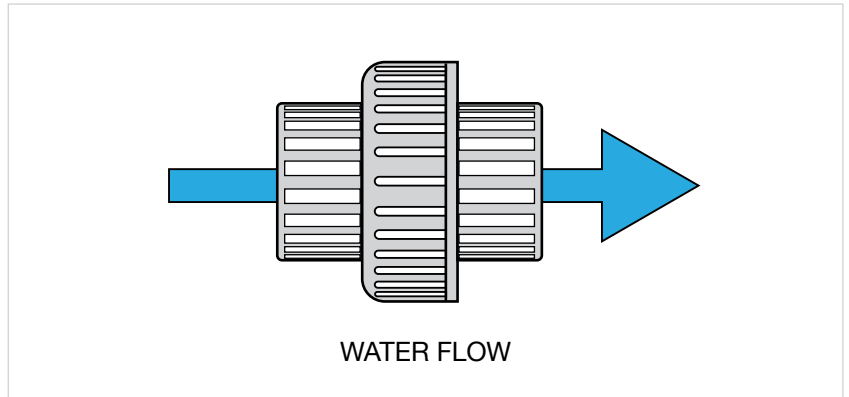
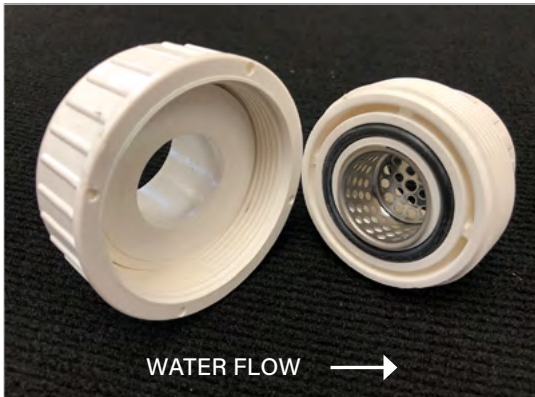

Tested Air Leakage Rate of Des Champs Air-Traps

Tested by N. H. Des Champs during month of November, 2021

Average CFM Leakage Between 0.5" and 12" WC

Model	CFM
P-Series	0.117
N-Series	0.058
RLC	0.069
FCN	0.034
PLP-051	0.101
PLP-084	0.168

Example Showing that Leakage Rate is Almost Independent of Delta P across Air-Trap

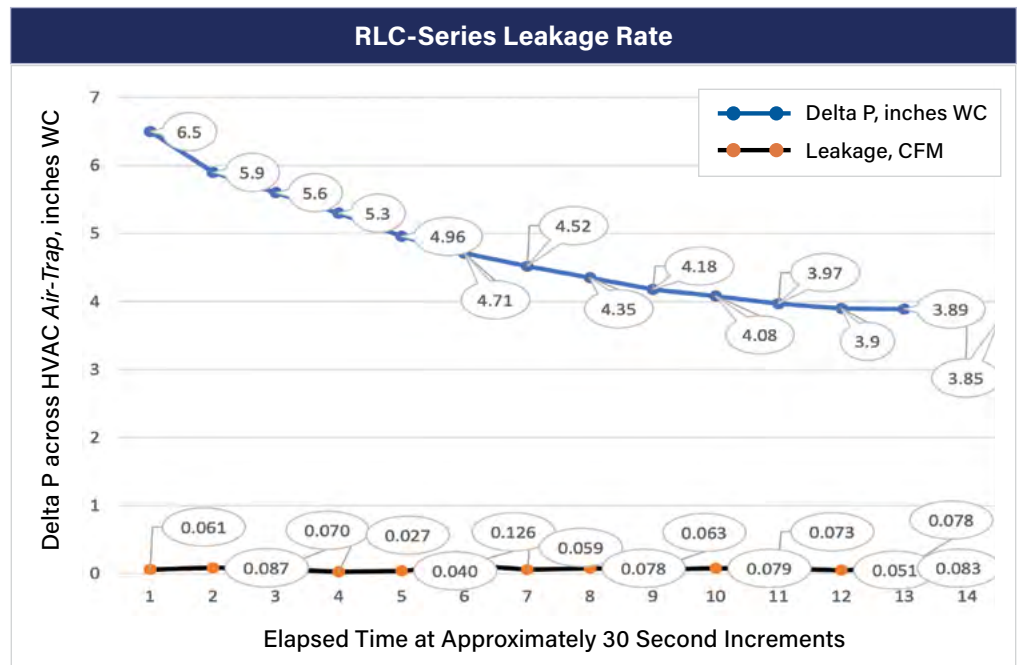

Air-Trap Leakage Test Arrangement

The balloon is pressurized until its diameter is 12 inches, the pressure fan is turned off and the pressure in the balloon (delta p across the sealing seat of the Air-Trap) is measured every 30 seconds until the balloon reached a diameter of 5 inches. The difference in volume of the balloon at the beginning of the test and at the end is the volume of air leaked through the Air-Trap seal. Divide the change in volume of the balloon by the time and you get the leakage rate in CFM.

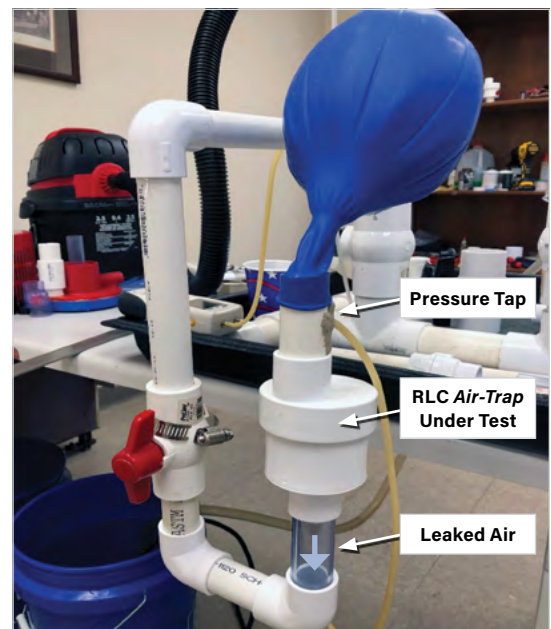

Tested Air Leakage Rate of Des Champs Air-Traps

Tested by N. H. Des Champs during month of November, 2021

Below is a 2nd Test to Double Check the Leakage Using a Much Larger Balloon at Lower Pressure.

With 2' diameter balloon, tested RLC-Series

Start of test: 26.1" diameter balloon
 End of test: 23.87" diameter balloon

21 minutes to leak 1.266 cubic feet

leakage rate = 0.060 CFM @ at average ΔP of 2.25 inches WC

Minutes	Delta P inches WC
0	3.16
1	3.00
2	2.86
3	2.72
4	2.62
5	2.53
6	2.45
7	2.37
8	2.30
9	2.24
10	2.18
11	2.12
12	2.07
13	2.02
14	1.97
15	1.93
16	1.98
17	1.84
18	1.81
19	1.78
20	1.75
21	1.72
	2.25 inches WC average over test



Analysis of Energy Wasted when Injecting Ambient Air Downstream of Cooling Coil

Explanation of Why Ambient Air Being Injected Upstream of a Cooling Coil, such as from a Leaky Return Duct or Cabinet, Consumes Less Cooling Energy than an Equal Amount of Ambient Air Injected Directly Downstream of Cooling Coil, Such as Would be the Case with Condensate Drain Piping Sucking in Ambient Air.

The reason for the explanation is twofold, **1)** to show that air being drawn into the AC unit through a dry P-trap located downstream of a cooling coil raises the supply air temperature whenever the coil is cooling and **2)** that additional compressor energy is required, either by reducing coil temperature or increasing total flow of conditioned air to the space. **Figure 1** is a psychrometric chart for ambient air mixing with return air prior to the coil and then cooling to 55°F after the coil. **Figure 2** shows what occurs when the same amount of ambient air is injected downstream of the coil where it mixes with the already cooled return air at 55°F – the mixed air at 57.2°F is delivered to the supply fan. **Figure 3** determines the added energy required by the mechanical refrigeration to cool the return air to 52.5°F so that when it mixes with the ambient air down stream of the cooling coil the mixture will be 55°F. The following is a summary of energy requirements for the three processes:

Process	Total Energy Required, Btu/hr	Delivery Temp., °F
Introduction of ambient air upstream of cooling coil	64,367	55
Introduction of ambient air downstream of cooling coil	60,344	57.2
Increased energy required to cool return air to 52.5°F so that when mixed with ambient air result will be 55°F	71,801	55
Wasted energy when introducing ambient air downstream of cooling coil as would be the case with a dry trap that allows ambient air to be sucked into chamber where drain pan is located.	11,457	

Figure 1: Return Air and Outside Air mixed prior to draw-through Cooling Coil

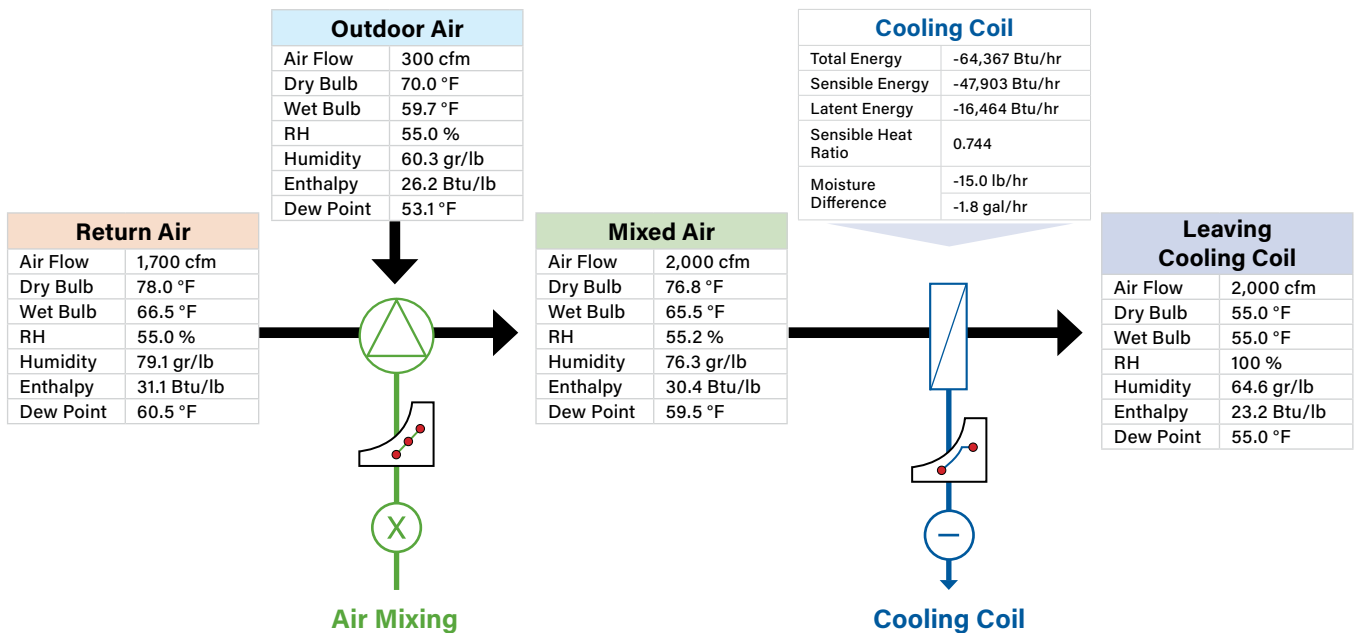
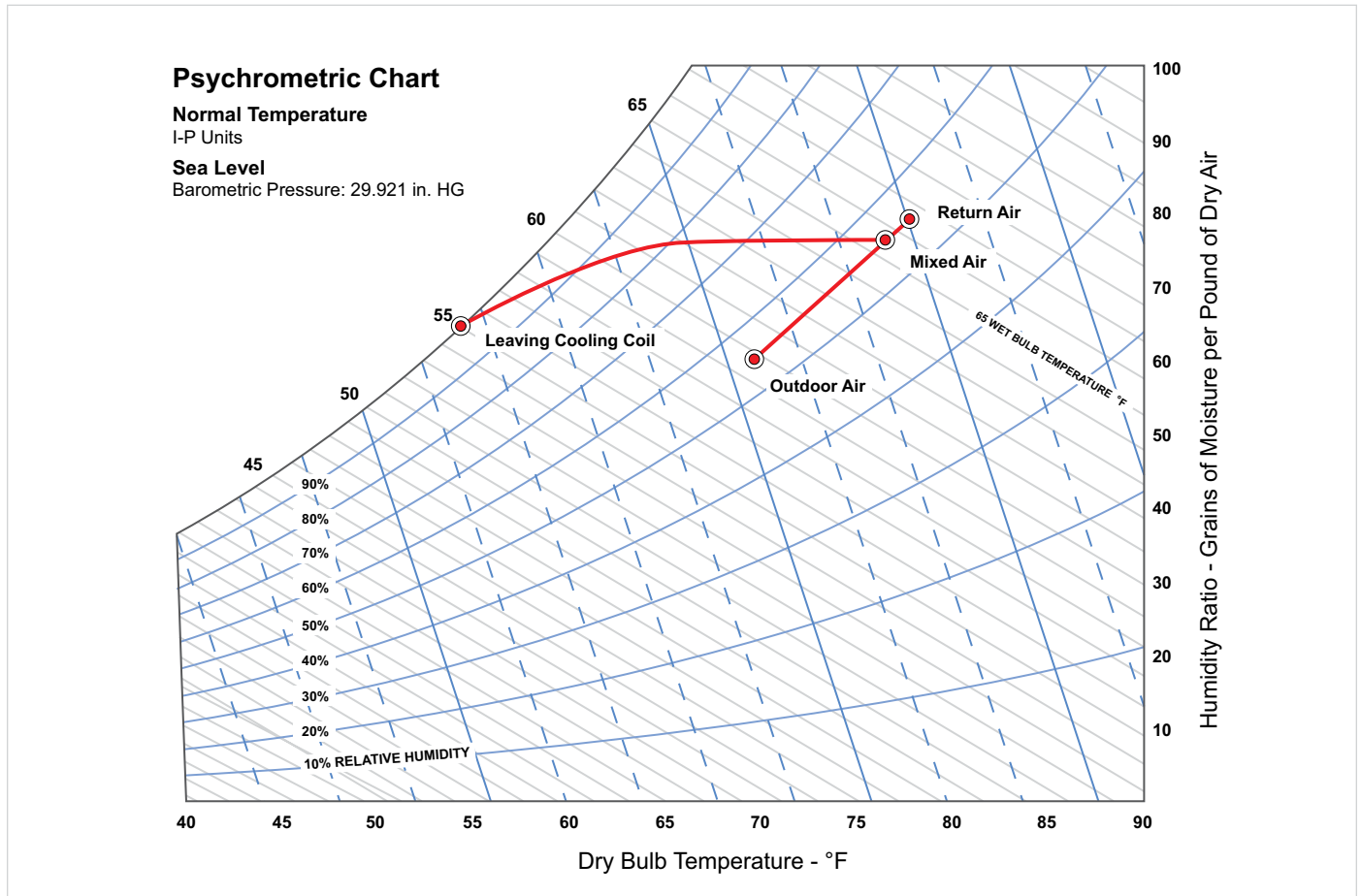

Figure 2: Cool Return Air to 55°F and then Mix with incoming Ambient Air before going to Space at 57°F

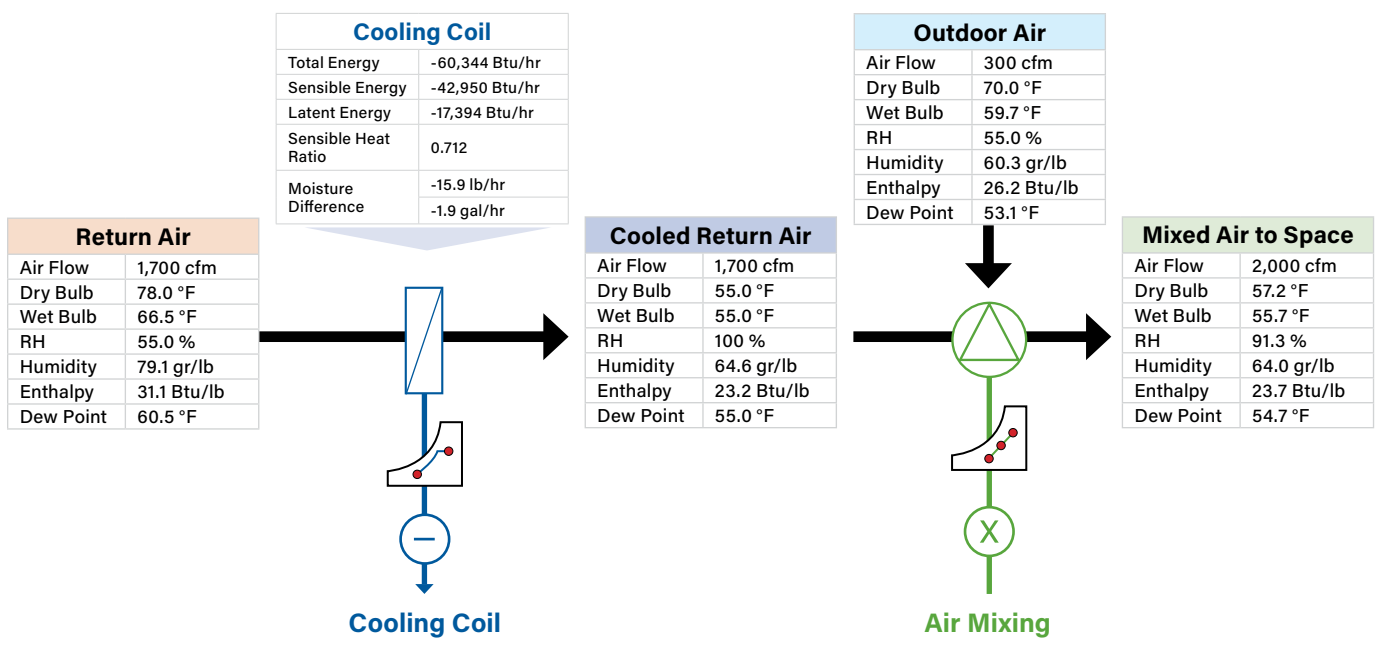
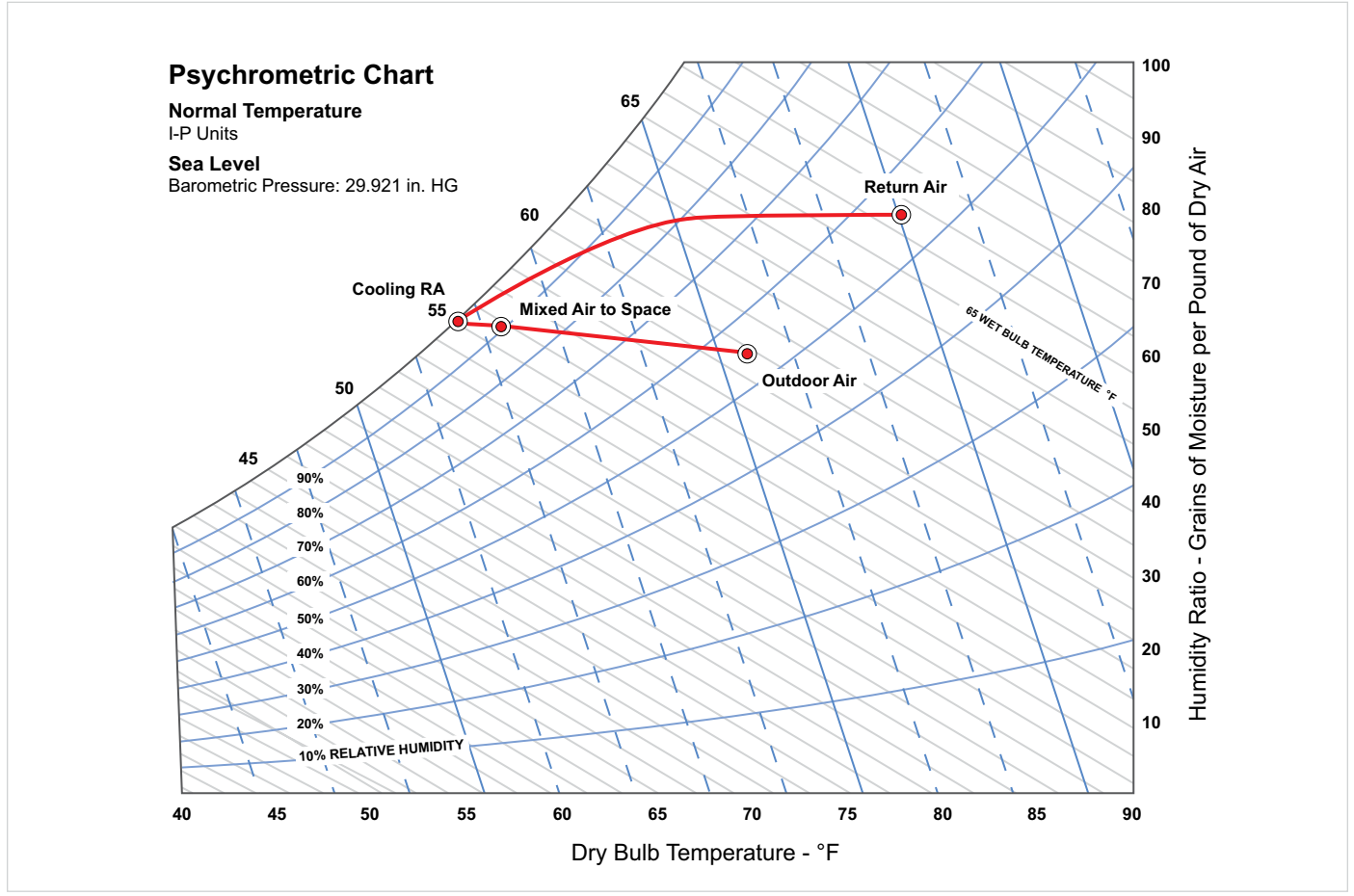
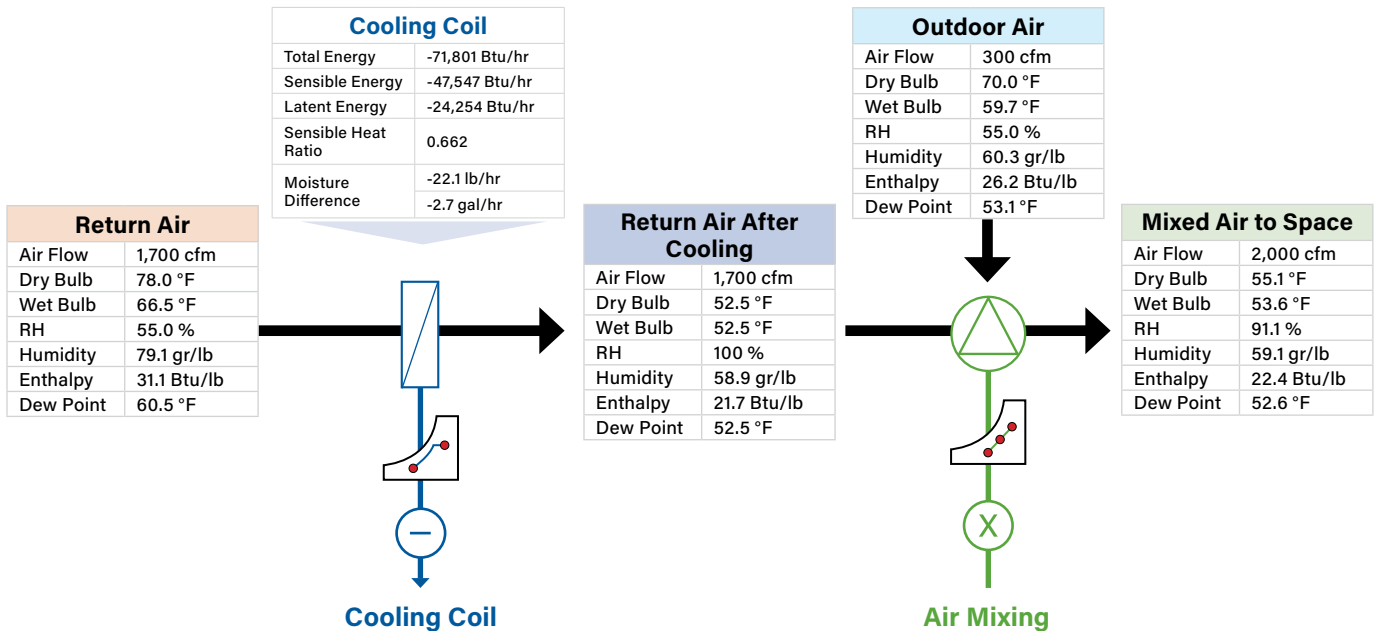
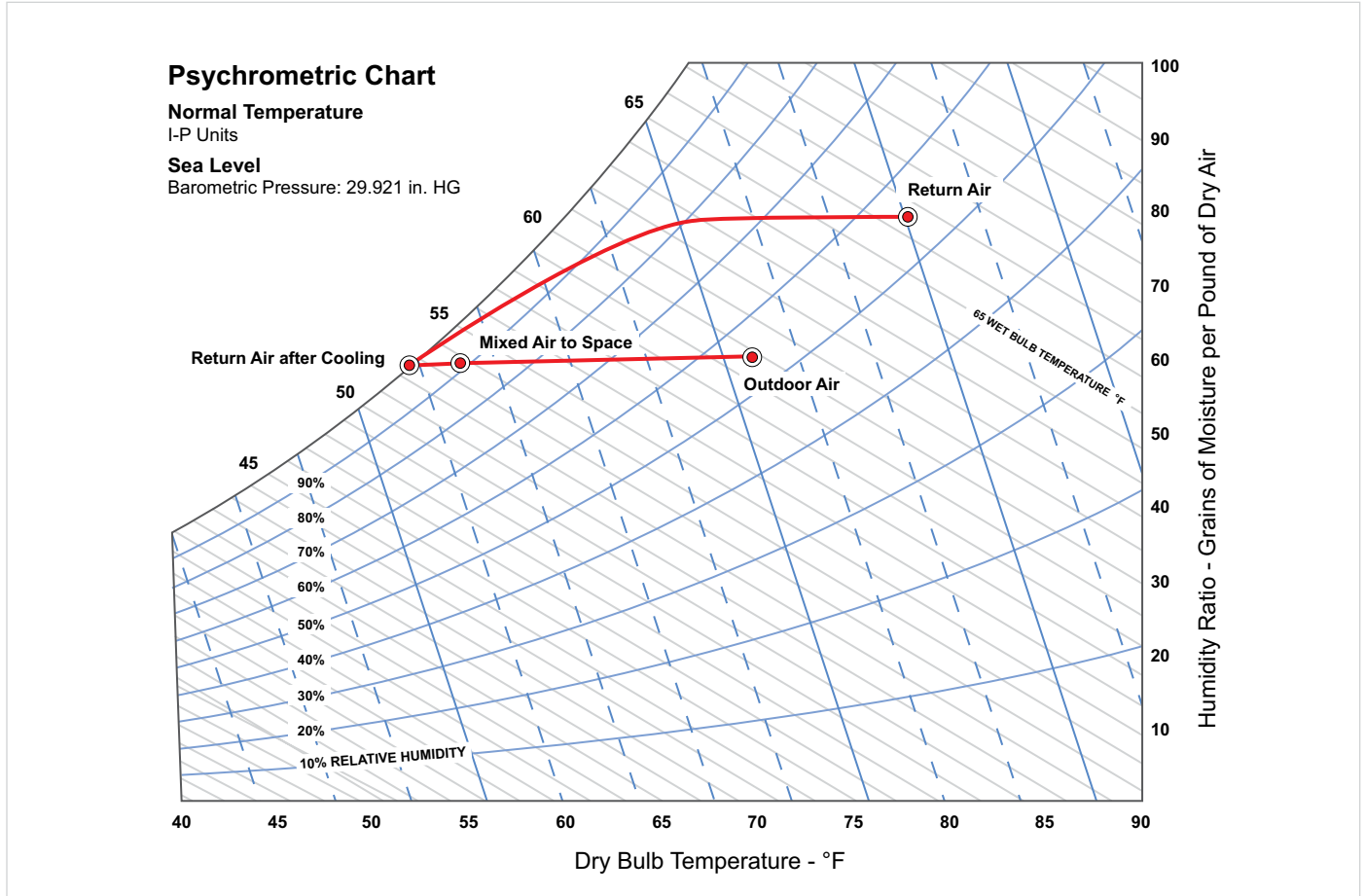

Figure 3: Cool Return Air to 52.5°F and then Mix with Incoming Ambient Air between the Cooling Coil and the Supply Fan to Match Space Cooling Load





Technical Data Sheet

Geon™ Vinyl Rigid Molding M4300 Rigid Polyvinyl Chloride

Key Characteristics

General	
Material Status	• Commercial: Active
Regional Availability	• Africa & Middle East • Asia Pacific • Europe • Latin America • North America
Features	• General Purpose • High Impact Resistance • Medium Flow
Uses	• Fluid Handling • General Purpose
Agency Ratings	• NSF STD-61 • NSF Unspecified Rating
Appearance	• Clear/Transparent
Forms	• Pellets

Technical Properties ¹

Physical	Typical Value (English)	Typical Value (SI)	Test Method
Density / Specific Gravity	1.32	1.32	ASTM D792
Spiral Flow	23.0 in	58.4 cm	
Molding Shrinkage - Flow	2.0E-3 to 5.0E-3 in/in	0.20 to 0.50 %	ASTM D955
Mechanical	Typical Value (English)	Typical Value (SI)	Test Method
Tensile Modulus ²	410000 psi	2830 MPa	ASTM D638
Tensile Strength ² (Yield)	7900 psi	54.5 MPa	ASTM D638
Tensile Elongation ² (Break)	30 %	30 %	ASTM D638
Flexural Modulus	400000 psi	2760 MPa	ASTM D790
Flexural Strength	11500 psi	79.3 MPa	ASTM D790
Impact	Typical Value (English)	Typical Value (SI)	Test Method
Notched Izod Impact			ASTM D256A
32°F (0°C), 0.125 in (3.18 mm), Injection Molded	1.0 ft·lb/in	53 J/m	
73°F (23°C), 0.125 in (3.18 mm), Injection Molded	16 ft·lb/in	850 J/m	
Hardness	Typical Value (English)	Typical Value (SI)	Test Method
Durometer Hardness (Shore D)	81	81	ASTM D2240
Thermal	Typical Value (English)	Typical Value (SI)	Test Method
Deflection Temperature Under Load			ASTM D648
66 psi (0.45 MPa), Unannealed, 0.250 in (6.35 mm)	158 °F	70.0 °C	
Deflection Temperature Under Load			ASTM D648
66 psi (0.45 MPa), Annealed, 0.250 in (6.35 mm)	169 °F	76.1 °C	
Deflection Temperature Under Load			ASTM D648
264 psi (1.8 MPa), Unannealed, 0.250 in (6.35 mm)	154 °F	67.8 °C	
Deflection Temperature Under Load			ASTM D648
264 psi (1.8 MPa), Annealed, 0.250 in (6.35 mm)	163 °F	72.8 °C	

Geon™ Vinyl Rigid Molding M4300

Technical Data Sheet

Flammability	Typical Value (English)	Typical Value (SI)	Test Method
Flame Rating			UL 94
0.06 in (1.5 mm), ALL	V-0	V-0	
0.08 in (1.9 mm), ALL	5VA	5VA	
Optical	Typical Value (English)	Typical Value (SI)	Test Method
Transmittance ³ (125 mil (3180 μm))	78.0 %	78.0 %	ASTM D1003
Haze (125 mil (3180 μm))	4.0 %	4.0 %	ASTM D1003

Processing Information

Injection	Typical Value (English)	Typical Value (SI)
Processing (Melt) Temp	390 to 400 °F	199 to 204 °C

Notes

- ¹ Typical values are not to be construed as specifications.
- ² Type I, 2.0 in/min (51 mm/min)
- ³ CIE Illuminant C

CONTACT INFORMATION

Americas	Asia	Europe
United States - Avon Lake +1 440 930 1000	China - Guangzhou +86 20 8732 7260	Germany - Gaggenau +49 7225 6802 0
United States - McHenry +1 815 385 8500	China - Shenzhen +86 755 2969 2888	Spain - Barbastro (Huesca) +34 974 310 314
	China - Suzhou +86 512 6823 24 38	
	China - Suzhou +86 512 6265 2600	
	Hong Kong - +852 2690 5332	
	Taiwan - Yonghe City, +886 9396 99740, +886 2929 1849	



Beyond Polymers.
Better Business Solutions. SM
www.polyone.com

PolyOne Americas	PolyOne Asia	PolyOne Europe
33587 Walker Road Avon Lake, Ohio 44012 United States +1 440 930 1000 +1 866 POLYONE	No. 88 Guoshoujing Road Z.J Hi-tech Park, Pudong Shanghai, 201203, China +86 21 5080 1188	6 Giällewee +352 269 050 35

Copyright ©, 2017 PolyOne Corporation. PolyOne makes no representations, guarantees, or warranties of any kind with respect to the Information contained in this document about its accuracy, suitability for particular applications, or the results obtained or obtainable using the information. Some of the Information arises from laboratory work with small-scale equipment which may not provide a reliable indication of performance or properties obtained or obtainable on larger-scale equipment. Values reported as "typical" or stated without a range do not state minimum or maximum properties; consult your sales representative for property ranges and min/max specifications. Processing conditions can cause material properties to shift from the values stated in the Information. PolyOne makes no warranties or guarantees respecting suitability of either PolyOne's products or the Information for your process or end-use application. You have the responsibility to conduct full-scale end-product performance testing to determine suitability in your application, and you assume all risk and liability arising from your use of the Information and/or use or handling of any product. POLYONE MAKES NO WARRANTIES, EXPRESS OR IMPLIED, INCLUDING, BUT NOT LIMITED TO, IMPLIED WARRANTIES OF MERCHANTABILITY AND FITNESS FOR A PARTICULAR PURPOSE, either with respect to the Information or products reflected by the Information. This data sheet shall NOT operate as permission, recommendation, or inducement to practice any patented invention without permission of the patent owner.

Axiall PVC 5009

Rigid Polyvinyl Chloride

Axiall Corporation

PROSPECTOR®

www.ulprospector.com

Technical Data

Product Description

AXIALL's Georgia Gulf 5009 is a type I, Grade I rigid vinyl injection molding compound designed for fittings and parts of similar configuration where maximum tensile strength and/or chemical resistance is required. It has full NSF approval and is suitable for all types of water distribution systems, including pressure fittings.

General

Material Status	• Commercial: Active		
UL Yellow Card ¹	• E53006-243307		
Search for UL Yellow Card	• Axiall Corporation		
Availability	• North America		
Features	• Chemical Resistant	• High Strength	
Uses	• Fittings	• Piping	• Plumbing Parts
Agency Ratings	• ASTM D 1784 12454B	• NSF STD-14	
UL File Number	• E53006		
Forms	• Pellets		
Processing Method	• Injection Molding		

Physical	Nominal Value (English)	Nominal Value (SI)	Test Method
Specific Gravity	1.39	1.39 g/cm ³	ASTM D792
Molding Shrinkage - Flow	2.0E-3 to 4.0E-3 in/in	0.20 to 0.40 %	ASTM D955
PVC Cell Classification	12454-B	12454-B	ASTM D1784
Mechanical	Nominal Value (English)	Nominal Value (SI)	Test Method
Tensile Modulus	400000 psi	2760 MPa	ASTM D638
Tensile Strength	7000 psi	48.3 MPa	ASTM D638
Flexural Modulus	390000 psi	2690 MPa	ASTM D790
Flexural Strength	12000 psi	82.7 MPa	ASTM D790
Impact	Nominal Value (English)	Nominal Value (SI)	Test Method
Notched Izod Impact			ASTM D256
-4°F (-20°C), 0.250 in (6.35 mm)	0.60 ft·lb/in	32 J/m	
73°F (23°C), 0.250 in (6.35 mm)	0.80 ft·lb/in	43 J/m	
Gardner Impact ³ (73°F (23°C))	320 in·lb	36.2 J	ASTM D3029
Drop Impact Resistance (73°F (23°C))	2.60 in·lb/mil	116 J/cm	ASTM D4226
Hardness	Nominal Value (English)	Nominal Value (SI)	Test Method
Rockwell Hardness (R-Scale)	115	115	ASTM D785
Thermal	Nominal Value (English)	Nominal Value (SI)	Test Method
Deflection Temperature Under Load			ASTM D648
66 psi (0.45 MPa), Unannealed	165 °F	74.0 °C	
264 psi (1.8 MPa), Unannealed	158 °F	70.0 °C	
Flammability	Nominal Value (English)	Nominal Value (SI)	Test Method
Flame Rating	V-0	V-0	UL 94
Oxygen Index	38 %	38 %	ASTM D2863

Additional Information

Flow Ratio (Distance/Wall Thickness), 390°F: 130

Injection	Nominal Value (English)	Nominal Value (SI)
Drying Temperature	150 °F	66 °C
Drying Time	2.0 to 4.0 hr	2.0 to 4.0 hr
Drying Time, Maximum	6.0 hr	6.0 hr
Suggested Shot Size	35 to 75 %	35 to 75 %
Suggested Max Regrind	50 %	50 %
Rear Temperature	325 °F	163 °C
Middle Temperature	345 to 375 °F	174 to 191 °C
Front Temperature	360 to 380 °F	182 to 193 °C
Nozzle Temperature	350 to 380 °F	177 to 193 °C
Processing (Melt) Temp	395 to 410 °F	202 to 210 °C
Mold Temperature	60 to 120 °F	16 to 49 °C
Injection Pressure	12000 to 20000 psi	82.7 to 138 MPa
Holding Pressure	7000 to 12000 psi	48.3 to 82.7 MPa
Back Pressure	50.0 to 200 psi	0.345 to 1.38 MPa
Screw Speed	25 to 80 rpm	25 to 80 rpm
Clamp Tonnage	2.5 tons/in ²	3.4 kN/cm ²
Screw L/D Ratio	16.0:1.0 to 24.0:1.0	16.0:1.0 to 24.0:1.0
Screw Compression Ratio	1.5:1.0 to 2.5:1.0	1.5:1.0 to 2.5:1.0

Notes

¹ A UL Yellow Card contains UL-verified flammability and electrical characteristics. UL Prospector continually works to link Yellow Cards to individual plastic materials in Prospector, however this list may not include all of the appropriate links. It is important that you verify the association between these Yellow Cards and the plastic material found in Prospector. For a complete listing of Yellow Cards, visit the UL Yellow Card Search.

² Typical properties: these are not to be construed as specifications.

³ Method F, Geometry FB



HVAC *Air-Trap*[™]

WHITE PAPER

It's Time to Reconsider the Use of P-Traps for HVAC Condensate Removal

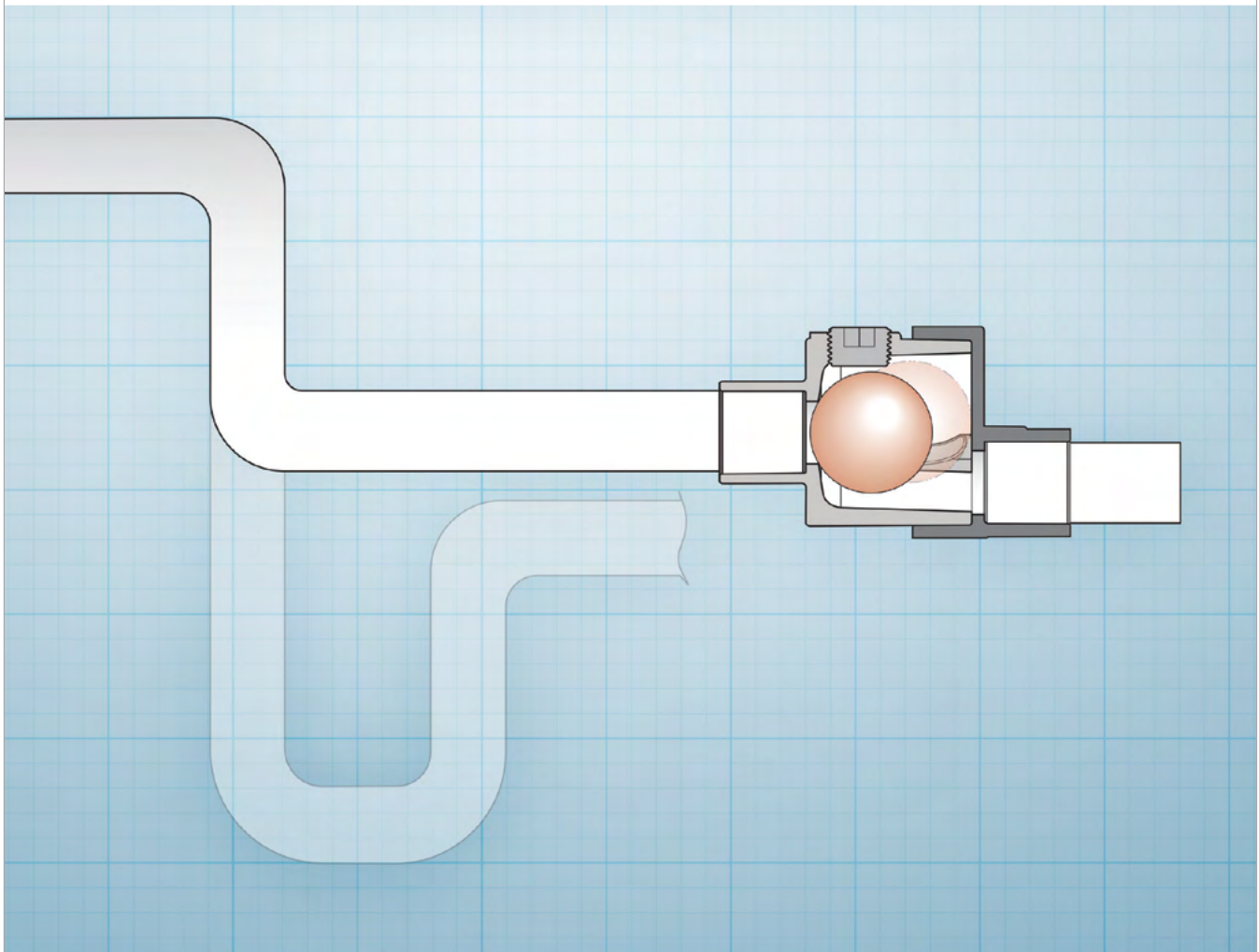

Nicholas H. Des Champs, Ph.D., PE, ASHRAE Fellow

When using a toilet to get rid of human waste or a sink to wash vegetables, the discarded product ends up in the same sewer line prior to its destination, the septic tank or sewage treatment plant. Obviously, you would not want the gases from the toilets to penetrate the kitchen where food is being prepared so an airtight seal is required between the appliances and the sewer line. Since the end of the 19th century, P-Traps have been used successfully for this purpose, for each incident enough water flows through the trap to move the waste from the source to the sewer while leaving water within the trap as a seal against air flow (refer to the diagram at right showing a piping arrangement that directs all household waste to a sewer connection). There are problems associated with the P-Trap when used in disposal systems, such as dry-out or freezing, but the benefits outweigh them.

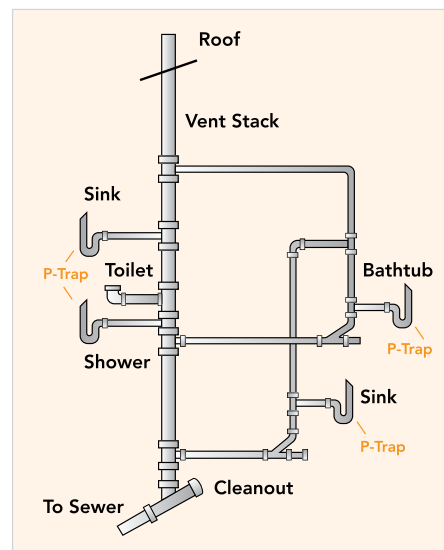

Since P-Traps seal against air leakage, they were the natural solution to prevent air leaking at the condensate drains of early 1900s air conditioning units. As air conditioning caught on in the 50s, P-Traps were the standard that every contractor field designed and installed, even if it was unknown to them whether the drain pan was at negative or positive pressure, or even at what level of pressure. It is still that way today. Air conditioning units are shipped from the factory to the job site without a condensate drain trap. The AC equipment is set on the slab, floor, or curb and it is the mechanical contractor’s job to install a P-Trap. Presently, most plumbing codes call for the use of a P-Trap on all appliances that are connected to a sanitary sewer. The only code requirements for drain lines removing condensate from HVAC equipment are:

- a) for the installation of a trap in accordance with the unit manufacturer’s installation and operating instructions
- b) that the lines slope toward the final drainage point at a rate of 1/8 inch per foot and
- c) that the size of the drainpipe meets the below requirements:

Size (tons)	0 - 20	21 - 40	41 - 60	61 - 100	101 - 250	251 & larger
Minimum Condensate Drain Size (inches)	3/4 to 1	1 to 1-1/4	1-1/4 to 1-1/2	1-1/2 to 2	2 - 3	3 or larger

The manufacturer’s instructions usually call for the line to be cleanable. More than likely, there will be no instructions or trap installation guidelines included within the HVAC unit installation manual. The information the engineer or contractor requires to properly design and install a HVAC condensate drain line with a standard P-Trap is:

- 1. Does the fan draw through the cooling coil (negative drain pan pressure) or blow through the cooling coil (positive drain pan pressure)?
- 2. The maximum operating pressure across the trap, i.e., drain pan compartment to ambient.
- 3. Maximum gallons of condensate per hour, required to size the drainpipe.
- 4. Inches per month water evaporation rate for the geographic area.
- 5. Greatest interval of time that condensate will not be produced (to determine depth of trap to prevent dry out).
- 6. Will the drain piping require a vent pipe immediately downstream of the condensate trap to prevent siphoning action?
- 7. Design guide for P-Traps

P-Trap Design Guide

Information that will aid the specifying engineer or contractor in the design and installation of a condensate line, using the standard P-Trap, is provided below.

Cooling Coil Draw-Through Arrangement - Condensate Drain Pan Under Negative Pressure

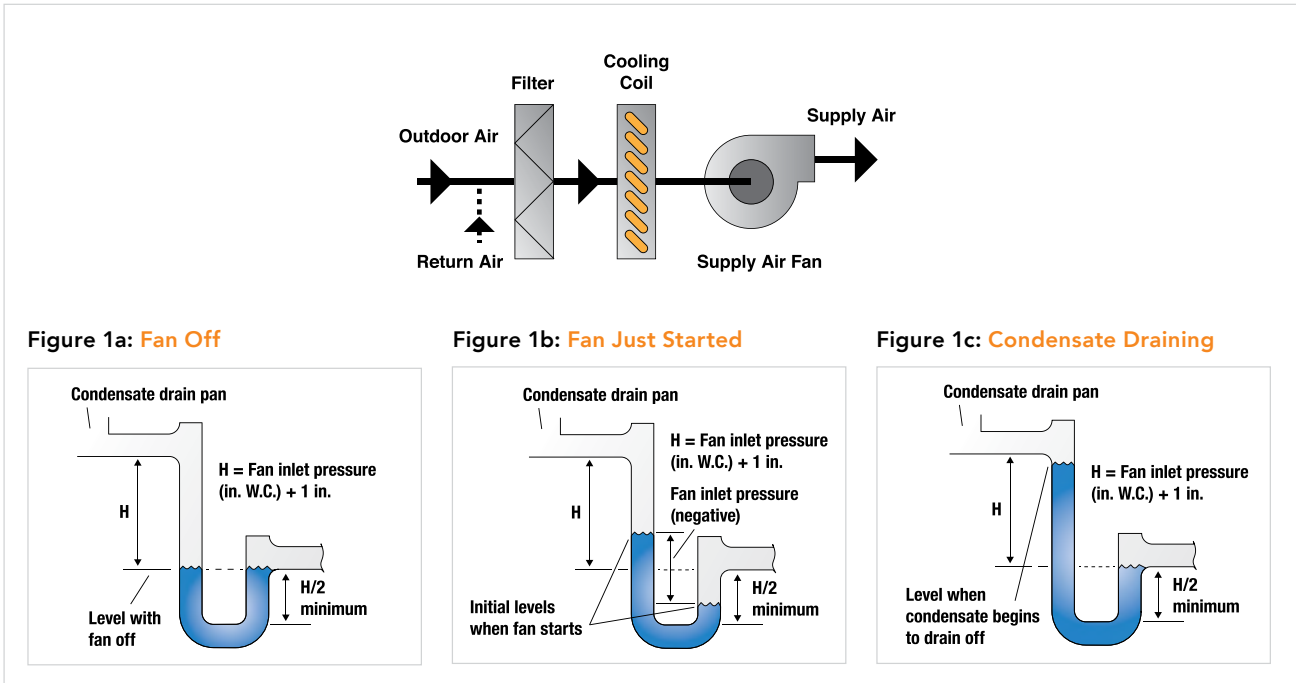

Cooling Coil Blow-Through Arrangement - Condensate Drain Pan Under Positive Pressure

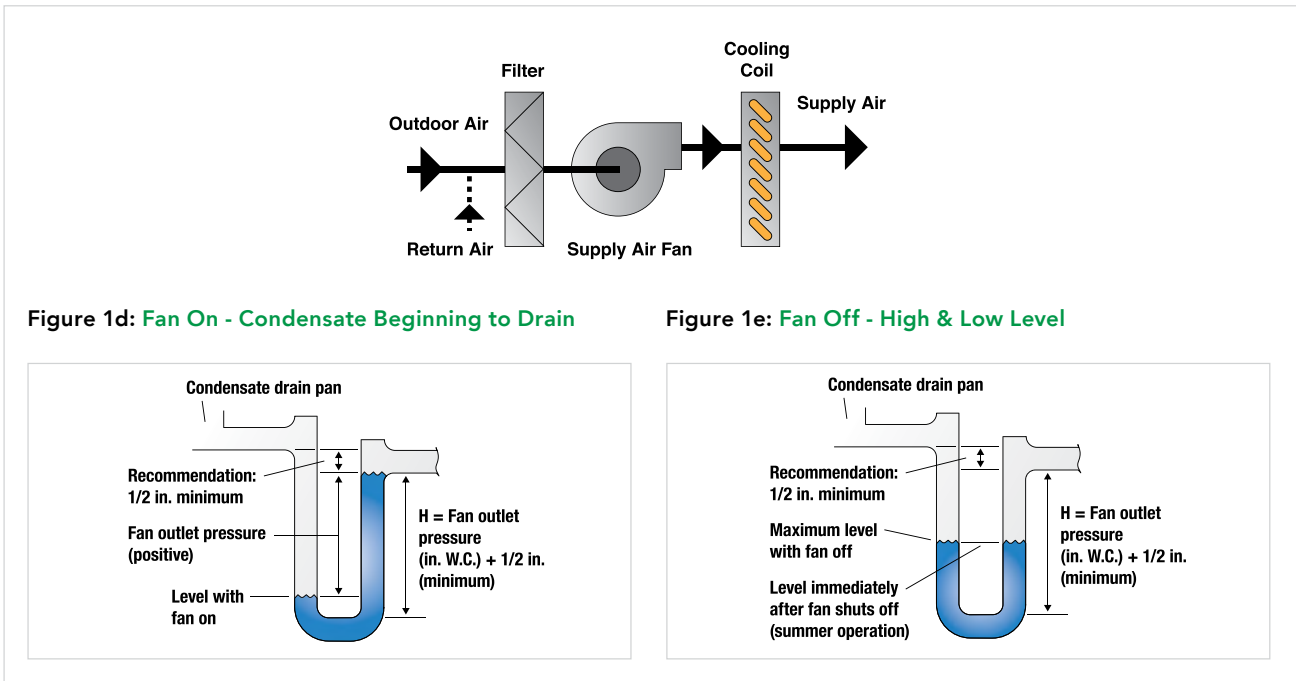

Estimated Cooling Coil Condensate Flow

Range	Average	Unitary Packaged AC Equipment	Air Handling Units			
			Outdoor Air			
0.02-0.08 GPM/ton	0.04 GPM/ton	0.006 GPM/ton	100%	50%	25%	15%
			0.100/GPM /1,000 cfm	0.065/GPM /1,000 cfm	0.048/GPM /1,000 cfm	0.041/GPM /1,000 cfm

If a P-Trap is to seal against airflow for the entire year, then there must be a water seal within the trap during the entire 365 days. To maintain a seal, the trap design must incorporate added height to accommodate water evaporation.

Rate at Which Water Evaporates within a P-Trap

Tests by the author indicate water will evaporate at a rate of approximately 2.2 inches per month from late spring through early fall. It does not make a difference if the drainpipe is 3/4 inch in diameter or 1-1/2 inch, or from a 20' x 40' swimming pool, the water evaporates at an average rate of 2.2 inches in height per month. The readings were taken near Roanoke, VA. If there is a drain line of considerable length that has pockets of water within the line after condensate ceases, then the evaporation rate in a P-Trap could be as low as 1.1 inches per month. In arid regions the evaporation rate will be higher, up to 3 inches per month. For example, if you have a residence in Las Vegas (Figure 5), and you are gone for six weeks, the toilet will have dried out by the time you return. Basically, dry P-Traps waste considerable energy as will be presented in the following paragraphs. A typical P-Trap design for draw-through equipment is shown in Figure 2. For a system operating at 1-1/2 inches of negative pressure, J will be 1-1/4 inches of height, which with an evaporation rate of 2 inches per month the seal will be lost after just two weeks of noncondensing operation! This is good reason to believe that P-Traps in most of the country run dry over 50% of the time.

Even worse is what has almost become standard for P-Traps in residential applications, a 3/4" bent PVC tube as shown in Figure 3a. With the trap set level and filled with water a test was run to see at what pressure the trap would cease to seal against air flow. The pressure was gradually increased from zero to the point where the water began to gurgle within the trap. For the inline trap a

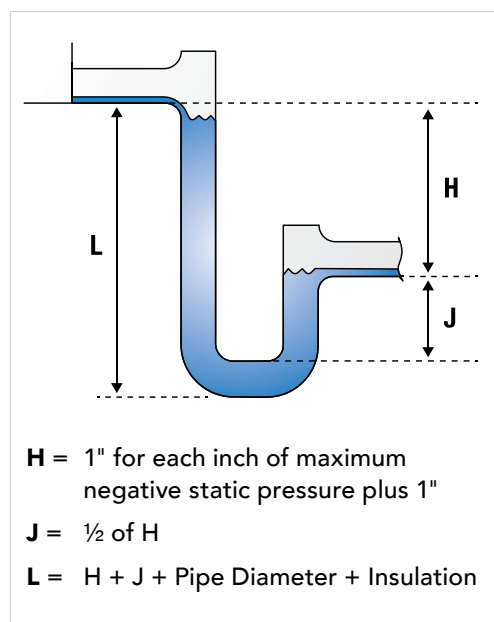

Figure 2: Accepted Design for a Negative Pressure P-Trap

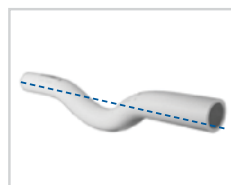

Figure 3a: Molded Trap made from a 3/4" PVC Pipe



Figure 3b: Molded 3/4" P-Trap

pressure of 5/8" WC caused the air seal to break. For the trap shown in **Figure 3b** it took 2 days to pass air at 5/8" WC. Both tests were run at 75°F and 50%RH.

The standard design for a P-Trap, as shown in **Figure 2**, does not fully take into consideration the evaporation of water from the trap over time. As already mentioned, a trap must seal against air leakage all year. For it to do that, two things must be taken into consideration: First, it must be designed with a water reservoir sufficiently deep or large to ensure the water seal is not evaporated away. Second, the water reservoir must be protected from freezing. Therefore, instead of H being equal to 1" for each inch of maximum negative static pressure plus 1", it should be 1" for each inch of maximum negative static pressure plus 1" + (N x E), where N = number of months without condensate being formed and E = the average evaporation rate of water in inches per month during the non-condensing period.

As an example, take an AC unit in Roanoke, VA, operating at 1-inch negative pressure, that is typically cooling from May through September, or five months of the year. That's seven months of no condensate formation. Referring to **Figure 4**, from October to April the average evaporation rate of the condensate is about 1.5 inches per month.

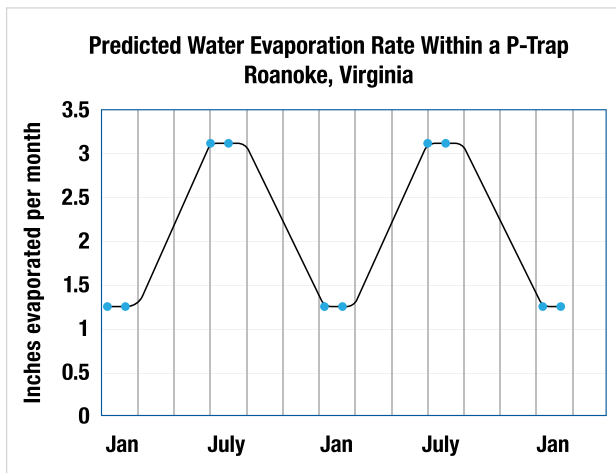

Figure 4

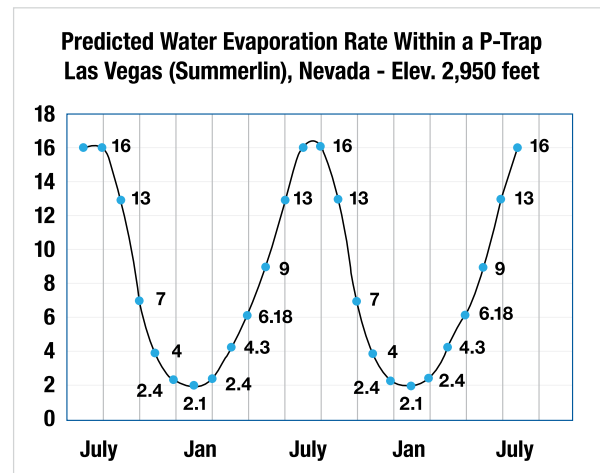

Figure 5

Using the revised formula:

$$H = 1 + 1 + (7 \times 1.5), \text{ or } 12.5 \text{ inches.}$$

$$J = \frac{1}{2} H = 6.25 \text{ inches.}$$

Therefore, the height of the trap $L = H + J + \text{pipe diameter} + \text{insulation}$

- or -

$$L = 12.5 + 6.25 + \frac{3}{4} + \frac{1}{2} \text{ or } 20 \text{ inches.}$$

Yeah, "really" you say. Well, I say check a residential trap in April before cooling season, anywhere except in Florida, and see if it has a water seal.



The picture to the left shows three P-Traps that have been removed from an attic heat pump air handler. All were replaced when AC service persons “solved a ceiling and wall flooding problem”. He said the traps had frozen, but as later discovered none were broken. What happened was the original installer did not connect a drain line to the safety pan under the unit. As a result, come spring, air sucked into the main drain pan area and caused a water geyser to occur as the air rushed in and the condensate tried to escape. The geyser caused water to overflow into the safety pan, but with no line to the final drain it ended up in a bathroom. The AC unit now has a proper fix: no air leakage, no condensate evaporation, no geyser, no chance of freezing, and no sludge buildup. It has a Des Champs HVAC Air-Trap™ RLC-Series.

The test stand used to determine the graphs shown in **Figures 4 and 5** is shown in **Figure 6**. The results of the evaporation tests do not include two important factors:

1. For an installed trap, when the fans are operating, there is air flow over the drain leading to the trap, which would tend to increase evaporation.
2. On the downstream side of the trap, there could be water sitting in the line and/or the drain line could extend a considerable distance before reaching its final destination, both instances leading to less evaporation.

Therefore, the results shown in **Figures 4 and 5** are an estimate of evaporation rate. It is known that condensate traps used in data center cooling equipment, that are designed to principally cool the DC using indirect air-side economization, but have backup mechanical cooling, must add water to the trap every several weeks to maintain an air seal. This issue led to the development of the **Des Champs HVAC Air-Trap™**, a trap product that does not require standing water to ensure an air seal. More on the HVAC Air-Trap when we compare the energy loss resulting from air leakage of P-Trap to that of the HVAC Air-Trap. But, before we get to the cost advantages of the HVAC Air-Trap compared to the P-Trap, let’s explore a real example of what takes place in the trap world. A contractor recently replaced five RTUs on our office building that were not that old but needed replacement because of considerable rust in the cooling section caused by ambient air being sucked in through the drain opening and preventing the condensate from flowing out of the drain into the drain line. The five replaced RTUs were all connected to a central drain line and none were trapped.



Figure 6: Test stand for measuring evaporation of water at different conditions



Figure 7: Des Champs HVAC Air-Trap RLC-Series

Rusting, deterioration of thermal insulation, bearing failure, shorting of fan motor, and wet interior office ceilings were all caused by the water geyser that results when water is attempting to escape from the drain, but the rush of incoming air blows the condensate throughout the cooling coil and fan compartment. The new installation, **Figure 7** is correctly installed with the new HVAC Air-Traps placed between the RTU and the main drain line.

Many installations do not allow for the proper P-Trap design because there is not enough height to have the trap retain the necessary amount of water to prevent dry-out. In fact, the trap will fail to operate properly at some point during the year. If the unit is in a tropical environment the P-Trap, with proper design can operate all year if cleaned on a regular basis to remove the sludge and growth buildup at the bottom of the trap. If installed in the arid west it will not seal against air flow for most of the year unless the P-Trap is primed on a regular basis (the trap will dry out at the rate of over 2 inches per month). In other areas of the country, the trap will either freeze and break or with no water will pass air. If heat tape is applied to keep the trap from freezing, then it's almost guaranteed the trap will be dry during winter months. As an example, for a trap to not dry out, and pass air, it would have to be designed to hold at least 8 inches of water at the end of a cooling season to seal air during the heating season and operate properly at the beginning of the next cooling season: this would require thermal insulation or heat tracing if the trap is exposed to freezing temperature. Basically, when using a P-Trap to remove condensate from an HVAC unit, you will encounter considerable air leakage to or from the occupied space during a year. The author's estimate of the percentage of time that a P-Trap operates dry is: South and Southeast 10% to 40%, Northeast 50%, North 60%, and West 80% plus. Contractors also tend to forget about energy losses when it comes to positive pressure applications.

Because the geyser problem does not exist with positive pressure P-Traps, it is much easier to simply leave the trap out of the drain line (*see Figure 8 below*). This tends to create a negative pressure in the conditioned space which would draw cold air in during the winter and hot, humid air in the summer. Both seasons will have moisture condensing within the building thermal insulation. Drain lines without traps were not taken into consideration in the above estimate of leakage and the below estimate of energy loss.



Q An expert HVAC contractor (Professional Member) answers the question: **Do you need a vent stack?**

A *"If your drain is on the positive side of the system, you don't even need the stack vent so yes you can cap it. I do it all day every day and never have any drain problems. You also don't need a drain trap on the positive side of the system. If you are using an air handler where the drain is on the negative side, you must have a trap. I make it a practice to just follow the installation instructions and local code."*

A Another expert: *"a positive pressure drainpipe is usually not an issue, just remove the trap."*

Figure 8: Online advice from the experts, self-explanatory

Air that leaks through a P-Trap has usually just been conditioned to cool or heat the space, so the energy lost is greater than for the same amount of room air leaking to ambient. It doesn't make any difference whether the conditioned air is being blown out of the unit (positive pressure) or drawn into the unit (negative pressure), the wasted air must be replenished, meaning that the makeup air must be filtered, and heated or cooled/dehumidified from ambient to supply air conditions, not return air conditions. Air is supplied at 55°F during cooling season and 110+ °F during heating. So, you are blowing air away at 55°F in summer and 110°F in winter.

Comparison of Air Leakage Through a Dry P-Trap and a HVAC Air-Trap

Leakage Rate of Air Through a Dry P-Trap

$$v = \sqrt{\frac{25,000 dp}{L}}$$

- v = velocity of air within drain line, ft/sec
- p = loss of pressure due to flow through the pipes, ounces/in²
- d = inside diameter of pipe, inches
- L = length of pipe, feet
- N = number of similar traps within conditioned space
- Qi = volumetric flow per trap, ft³/min
- Qt = total volumetric flow through N traps within conditioned space, ft³/min
- 25000 = unit conversion factor

p =	2.0 inches WC 1.1552 ounces/in ²	
d =	1.00 in	
L =	15.00 ft	
N =	1	
v =	(25,000 * p * d/L) ^{0.5} ft/sec	Air velocity through drain line
v =	43.9 ft/sec 2,632.7 ft/min	Velocity entering or leaving drain pan
Flow area =	0.0055 ft ²	Drain line flow area
Qi =	14.4 ft ³ /min	Air flow to or from cooling unit through drain line per P-Trap
Qt =	14.4 ft ³ /min	Total air flow through N number traps: conditioned make-up air is required to replace this leakage

Leakage Rate of Air Through an HVAC Air-Trap

The specific relationship among the pressure within the drain pan compartment, the ambient pressure, and the flow area between the float valve and the seat is expressed by the following equation:

Qi =	2610 * A * (ΔP) ^ 0.5
Where:	
ΔP =	pressure drop across ball valve seat, inches of water, which is = P1 - P2
A =	open area for flow between the ball valve and the seat, ft ²
2610 =	unit conversion factor dimensionless
D =	contact diameter between ball and seat, inches
D =	0.62 in
P1 =	2.00 in WC within drain pan
P2 =	0 in WC ambient
Peripheral Gap =	0.0005 in (average distance between float valve and seat)
A =	6.76317E-06 ft ²
Qi =	0.025 ft ³ /min per HVAC Air-Trap™ (confirmed by measurement)

Estimate of Energy Loss Through P-Traps Within the United States

April through September (AC Operation or 182 days)

Assume: 14 cents/kW-hr

Assume: operating 50% of time — of that time 25% dry or 12.5% of time running dry during cooling season

Operating 50 percent of time

Percentage dry 25 during operation

Average ΔT, F° 25 difference between conditioned supply air temperature and ambient

CFM from above calculation 14.4

$Q = 4.05 \times \text{CFM} \times (h_1 - h_2) = 915 \text{ Btu/hr per P-trap}$ or 0.268 kW

Using an average COP of 2.0 the energy in kW is 0.134 kW

Operating 50% of time — of that time 25% dry or 12.5% of time running dry

(Note: many installations have no traps installed)

Total kW-hrs per year per P-Trap at the above conditions = 70.4304

Total estimated energy cost per year per P-Trap = \$9.86

October through March (Heating Operation or 183 days)

Operating 50 percent of time

Percentage dry 80

Average ΔT, F° 70 difference between conditioned supply air temperature and ambient

CFM from above calculation 14.4

$Q = 1.085 \times \text{CFM} \times \Delta T = 1,088.6 \text{ Btu/hr}$

Assume operating 50% of time and 80% dry or 40% of time running dry and 80% efficient furnace.

Cost to heat lost air = \$9.56 per P-Trap

Estimated cost to condition lost air through P-Trap: \$19.42 per average P-Trap per year

Estimated that there are 200,000,000 HVAC P-Traps installed in the United States

Cost in Energy Consumed resulting from air lost through P-Traps = \$3,884,573,952

The above analysis considers only the energy wasted by the main drain line, it does not take into consideration the fact that many secondary overflow drains leak air of an equal amount as the primary drain but they leak air all the time the fan is operating. These lines, even if they have a P-trap, are always dry. Only a Des Champs Air-Trap will prevent air leakage on the secondary overflow drain line. **Please refer to the picture to the right for a better understanding of this statement. The contractor corrected the main drain with an Air-Trap but failed to correct the overflow drain, so it will lose conditioned air all the time because the overflow trap will essentially always be dry.**

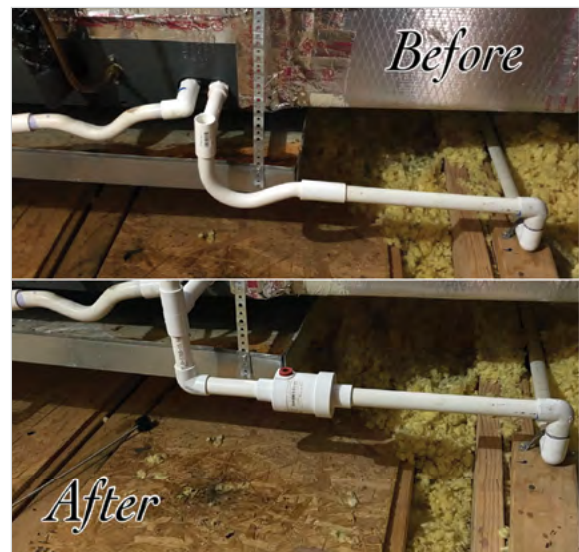

Stop Wasting Energy, Switch to the HVAC Air-Trap™

Sealing this leakage should be seriously considered by energy-conscious owners, specifying engineers, installing contractors, and government officials. The quickest, easiest, and most cost-effective way to reduce the wasted energy is to replace the installed traps with Des Champs HVAC Air-Trap and specify them to be used on new installations. Not only would the HVAC Air-Trap be saving “tons” on energy, but you would be eliminating the eight issues inherent with P-Traps:

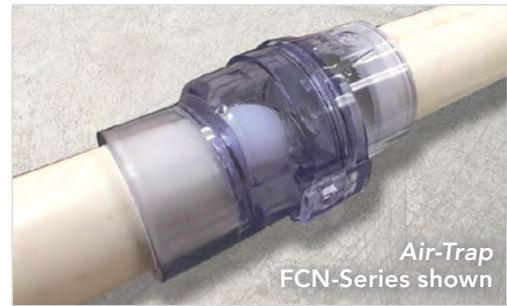

	Standard P-Trap Issues	HVAC Air-Trap™ Solution
1	Freezes and breaks	Operates dry when there is no condensate being produced, the trap and the drain line leading to the trap will not freeze
2	Dry-outs	Eliminates dry-out issue
3	Sludge formation at bottom of "U" tube	No accumulation of sludge. Operates dry when no condensate is flowing
4	Geyser effect of air rushing into drain pan and spraying water or causing overflow of drain pan	Eliminates geyser effect
5	Mold, mildew, and undesirable bacteria forming in the cooling-coil compartment	Prevents mold, mildew and undesirable bacteria by eliminating geyser effect which causes condensate to collect in the cooling-coil compartment
6	Air leakage	When removing water, the water exits the Air-Trap but no air escapes the unit.
7	Height requirement for trap to function properly	Less than ½ the height of a standard P-Trap
8	Incorrectly designed and installed	Pre-designed — eliminating errors caused by field designed P-traps

Owners would really appreciate saving the energy and not dealing with the eight issues resulting from P-Traps as well as the consequences of malfunctioning, especially water running down their walls when the AC units start up in the spring, as the author has witnessed on numerous occasions before the invention of the Air-Trap in 2014.

The Des Champs HVAC Air-Traps come in all sizes and shapes to cover essentially any condensate requirement. The P and N Series for commercial applications, the RLC for residential and light commercial, the FCN series for residential, hotels, apartment houses, and the PLP for positive pressure application where pressures up to 30 inches WC or more can be accommodated in a height of less than 3 inches. Our website can lead you to all the information you will need to get you started switching to a product that will eliminate the problems with P-Traps and energy loss, and result in a satisfied customer. www.deschampstechnologies.com
 — www.waterless-trap.com (online store)

Frequently Asked Questions

Question	Answer
How do I determine if the system is negative or positive pressure?	<div style="display: flex; justify-content: space-around;"> <div style="text-align: center;"> <p>Negative Pressure -Draw Through</p> </div> <div style="text-align: center;"> <p>Positive Pressure -Blow Through</p> </div> </div>
What is the maximum pressure the Air-Trap can withstand?	Please see table 2 below
What is the maximum liquid flow the Air-Trap can handle (GPM)?	Please see table 1 below
What is the maximum temperature the Air-Trap can withstand?	Please see information on Pages 53-56
How much height is required for the Air-Trap?	Please see formula in table 3 below
What sizes are available?	Please see table 2 below

1 Maximum Condensate Flow, GPM, at Pressure Shown in Inches Water Column

Air-Trap Series	Any Negative Pressure	Positive Pressure	Air-Trap Series	Negative Pressure	Positive Pressure
FCN	0.8	0.04 at 0.5" WC	P all connection sizes	N/A	0.5 at 12" WC
RLC	2.0	0.06 at 5" WC			1.0 at 8" WC
		0.19 at 4" WC			1.5 at 7" WC
		0.21 at 3" WC			2.0 at 4" WC
		0.21 at 2" WC			2.2 at 25" WC
N all connection sizes	2.0	0.06 at 5" WC	PLP-084	N/A	2.5 at 15" WC
		0.19 at 4" WC			4.0 at 0.5" WC
		0.21 at 3" WC			0.8 at 5" WC
		0.21 at 2" WC			0.95 at 2" WC

2 Sizes and Pressures

Air-Trap Series	Max Negative Pressure, inches WC	Max Positive Pressure, inches WC	Available Connection Sizes (inches)				Length (inches)
P	N/A	12	3/4	1	1-1/4	1-1/2	8
N	20	3	3/4	1	1-1/4	1-1/2	5.6
RLC	20	2.5	3/4	1 (with fitting)			4.65
FCN	5	0.5	3/4	1/2 (with fitting)			2.48
PLP-084	N/A	0 - 40	1-1/2		2 (with fitting)		7.75
PLP-051	N/A	0 - 5	3/4	1 (with fitting)			5.6

3 HVAC Air-Trap and Standard P-Trap Required Space Comparison

Plenum Pressure inches of WC	Standard P-Trap	HVAC Air-Trap™	Difference
	Minimum Required Height, Y*	Minimum Required Height, Y	
1	4	2	2
2	6	3	3
3	8	4	4
4	10	5	5
5	12	6	6
6	14	7	7
7	16	8	8
8	18	9	9
9	20	10	10
10	22	11	11

Measurements in inches

* Height "Y" for the standard P-Trap does not take into consideration any condensate evaporation of the condensate within the U-shaped section of the trap. Please refer to page 61 for information to guide you in the correct design of a P-Trap that allows the trap to hold water all year and prevent air leakage through the drain line.

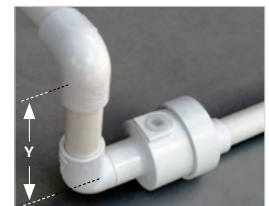

Dimension Y in inches is = negative pressure in inches of WC.

Total height of the Air-Trap is only the height of the negative pressure plus one inch for safety and not 2 times negative pressure plus two inches.

The table is for negative pressure systems since no water head is required for the Air-Trap in positive pressure systems.

Where to Buy

Retail

N-Series ▪ **P-Series** ▪ **RLC-Series** ▪ **FCN-Series** ▪ **PLP-Series**

Des Champs Technologies
Ph: 540.228.1967
Fax: 540.291.1270
www.waterless-trap.com

SUPCO - Sealed United Parts
Fax: 1 800 458 2818
www.supco.com

TruTech Tools
www.trutechtools.com

Union-Strainer ▪
Engineered Air-Trap

Des Champs Technologies
Ph: 540.228.1967
Fax: 540.291.1270
www.waterless-trap.com

Global Distributors

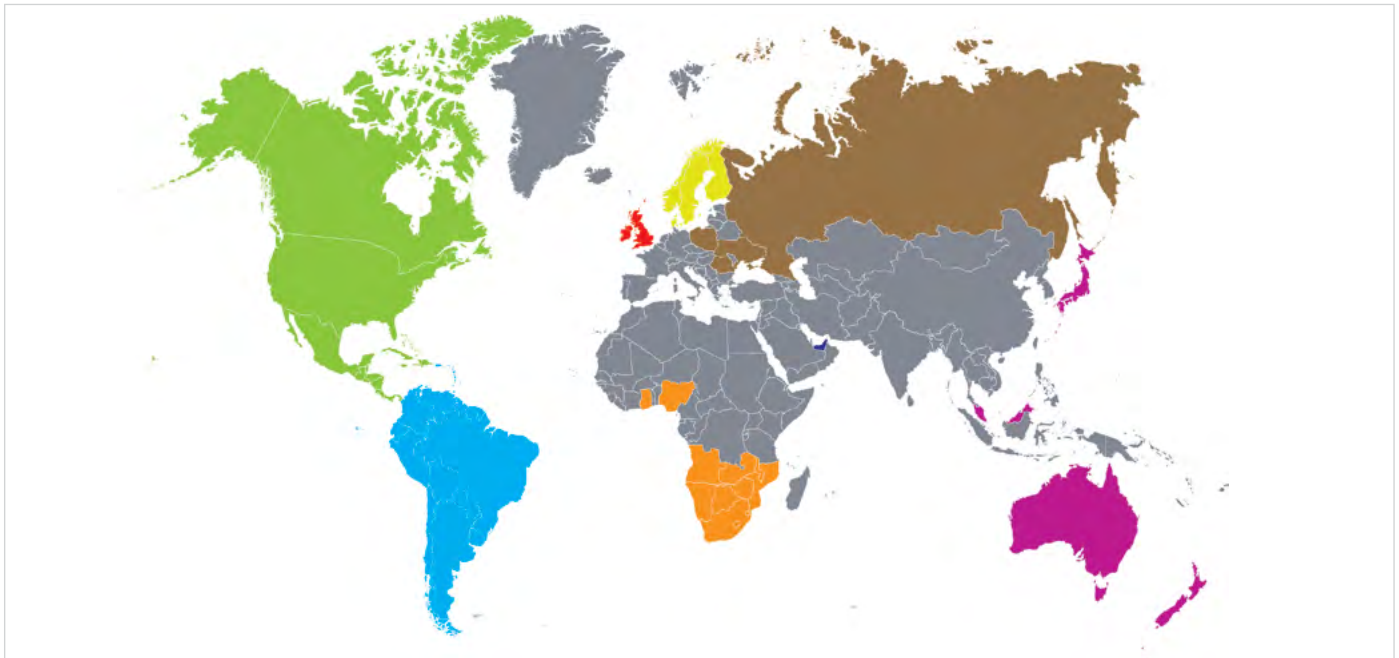

North America

SUPCO - Sealed United Parts
Fax: 1 800 458 2818
www.supco.com
Distributed to your local Wholesaler
Ask for the SUPCO, Sealed Unit Parts Air-Trap

Canada

infraAIR - A Division of infraStruct
Justin Schinnour
Sales and Service Canada
Located in Calgary
Tel: 403.823.0422
www.infraAIR.ca

Denmark, Sweden, Norway & Finland

Energiteknik Lolland ApS
Jesper Frederiksen
Klostervænget 1a
4900 Nakskov
+45 29440005
http://energitekniklolland.dk
https://www.air-trap.eu/Unit Parts Air-Trap

South Africa & surrounding countries

Consultaire
Tel: +27 11 674 4011
www.consultaire.co.za

UAE

MAGNA
PO Box: 117087, Dubai, UAE
Tel: +971 4 360 3136
Fax: +971 4 420 68 46
M: +971 50 625 16 82
https://www.magnamep.com/
Hussam Sbayteh
General Manager
h.sbayteh@magnamep.com

Australia, Japan, Malaysia, New Zealand

Pro Pipe Supplies Pty Ltd.
Tel: (08) 8186 4666
www.propipesupplies.com.au

South America

Comset
Tel: (47) 3366 2733

Poland, Romania, Ukraine & Russia

Grupa Innowacyjnych Technologii
ul. Energetyków 19
20-468 Lublin
Poland
Ph: +48 504-235-459
http://www.git-pl.pl/
Contact Name: Piotr Wójcik
e-mail: p.wojcik@git-pl.pl

Dublin, Ireland & UK

Ideal Cooling Equipment Ltd.
Klima House, Brookfield Avenue
Blackrock
County Dublin
A94 EOYO
T + 353-1- 2886739
M + 353- 87- 2557662
www.ice.ie

HVAC Air-Trap™

WATERLESS HVAC CONDENSATE TRAPS



2 Nikki Lane
Natural Bridge Station, VA 24579
Phone: 540.228.1967
Fax: 540.291.1270
info@deschampstechnologies.com
www.deschampstechnologies.com
www.waterless-trap.com

